

2 Operation

2.1 Explanation of Front and Rear Panel

2.1.1 Elements of the Front Panel

2.1.1.1 Display

(cf. Fig. 2-1, A Front panel view, display)

1

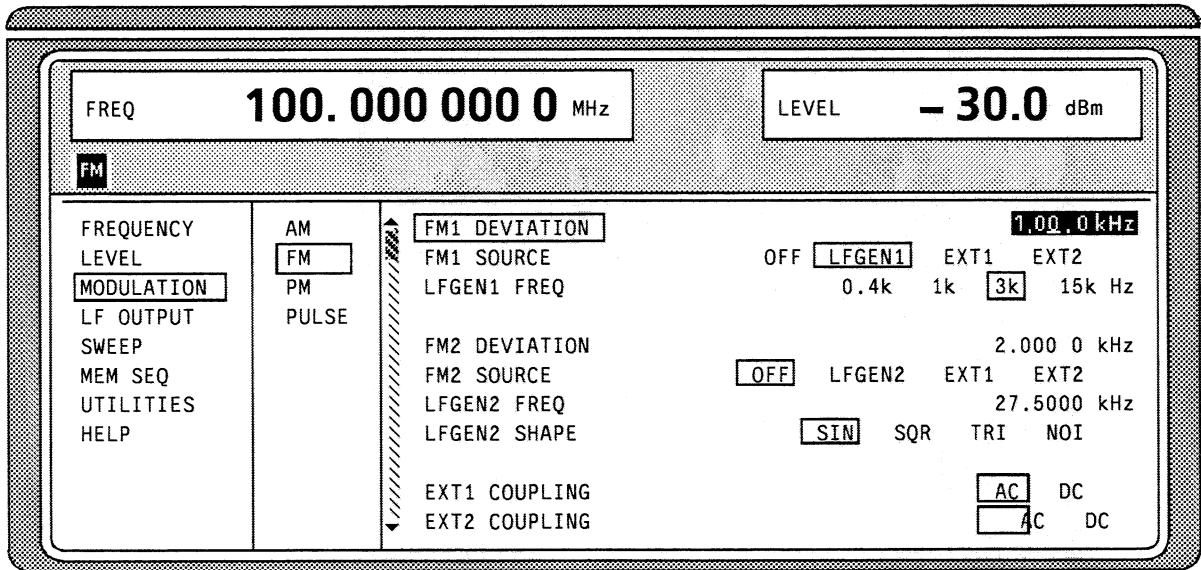

The display shows in the header field:

- the current frequency and level settings.
- status messages.
- error messages.

menu field:

- the main menu and the submenus selected with the current settings.

Parameters can be selected and changed in the menus indicated.

see as well
Section 2.2.1, Display

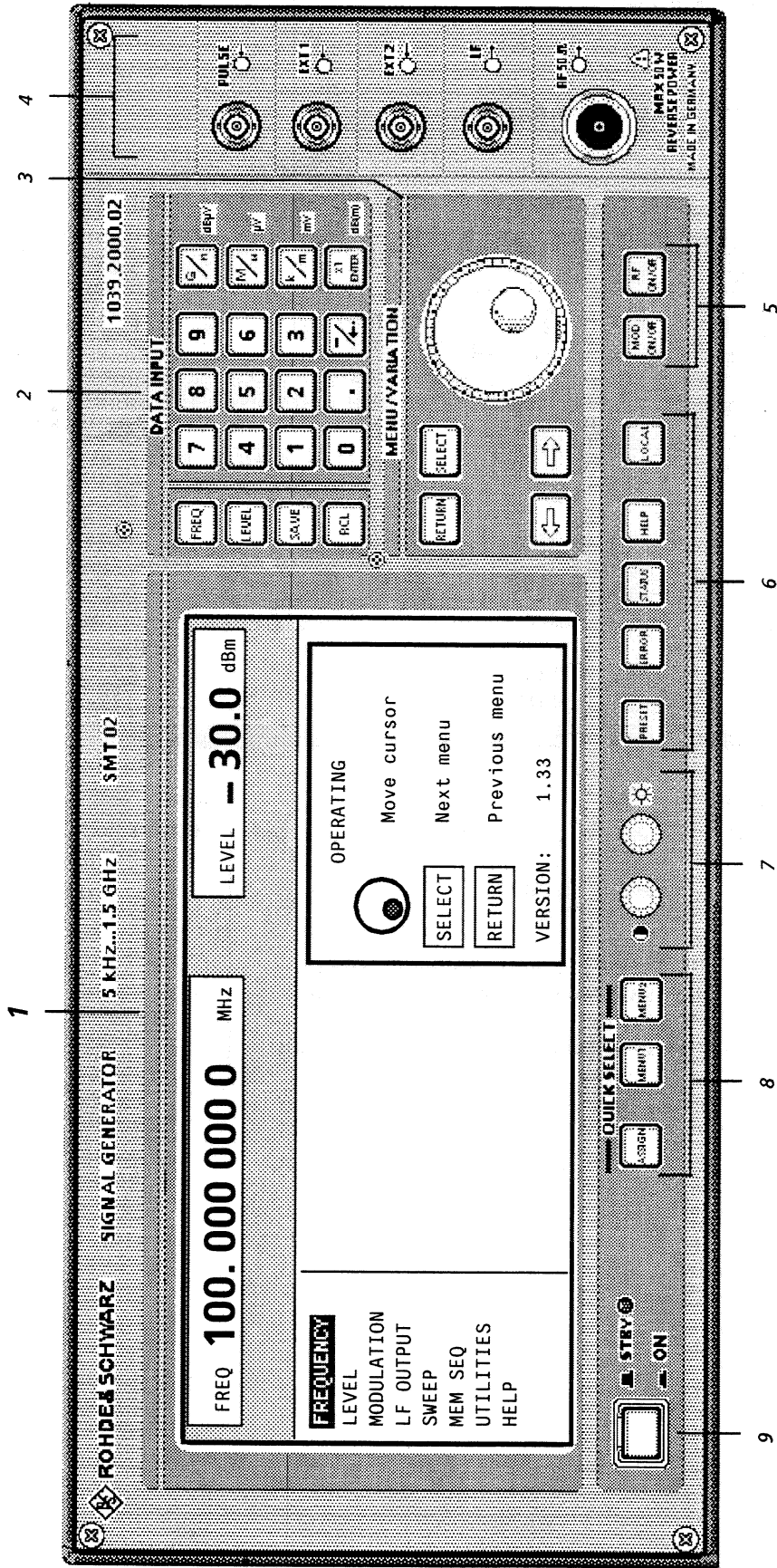

Fig. 2-1, A Front panel view, display

2.1.1.2 Controls

(cf. Fig. 2-1, B front panel view, controls)

2 DATA INPUT

Parameter field

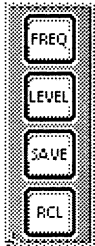

Parameters RF frequency and RF level can be entered directly by means of the parameter keys, alternatively to menu operation. The input value (indicated in the header field) considers the offset, see Sections 2.4 and 2.5. Further, complete instrument settings can be stored and called.

- FREQ** Opens the setting of the RF frequency via value input or variation by means of a rotary knob. The current menu is maintained. Return to the menu by means of the [RETURN] key. (Setting of the RF frequency also in the FREQUENCY menu).
- LEVEL** Opens the setting of the RF level via value input or variation by means of a rotary knob. The current menu is maintained. Return to the menu by means of the [RETURN] key. (Setting of the RF level also in the LEVEL menu).
- SAVE** Opens the storing of the current instrument setting. Memory selection is effected by entering a number (1 to 50) and is finished by means of the [ENTER] key.
- RCL** Opens the calling of an instrument setting stored. Memory selection is effected by entering a number (1 to 50) and is finished by means of the [ENTER] key.

see as well

Section 2.2.2.5,
Use of [FREQ] and
[LEVEL] Keys

Section 2.4,
RF Frequency

Section 2.5,
RF Level

Section 2.2.5,
Storing and Calling
of Instrument
Settings

Numeric input field

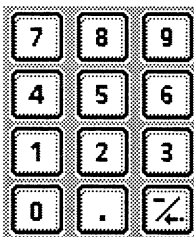

Numeric values, decimal point and minus sign can be entered by means of the digital keys.

- 0...9** Enters the digit.
- .** Enters the decimal point.
- /←** Enters the minus sign.
Deletes the last input (digit, sign or decimal point) – key [BACKSPACE].

see as well

Section 2.2.2,
Basic Operating
Steps

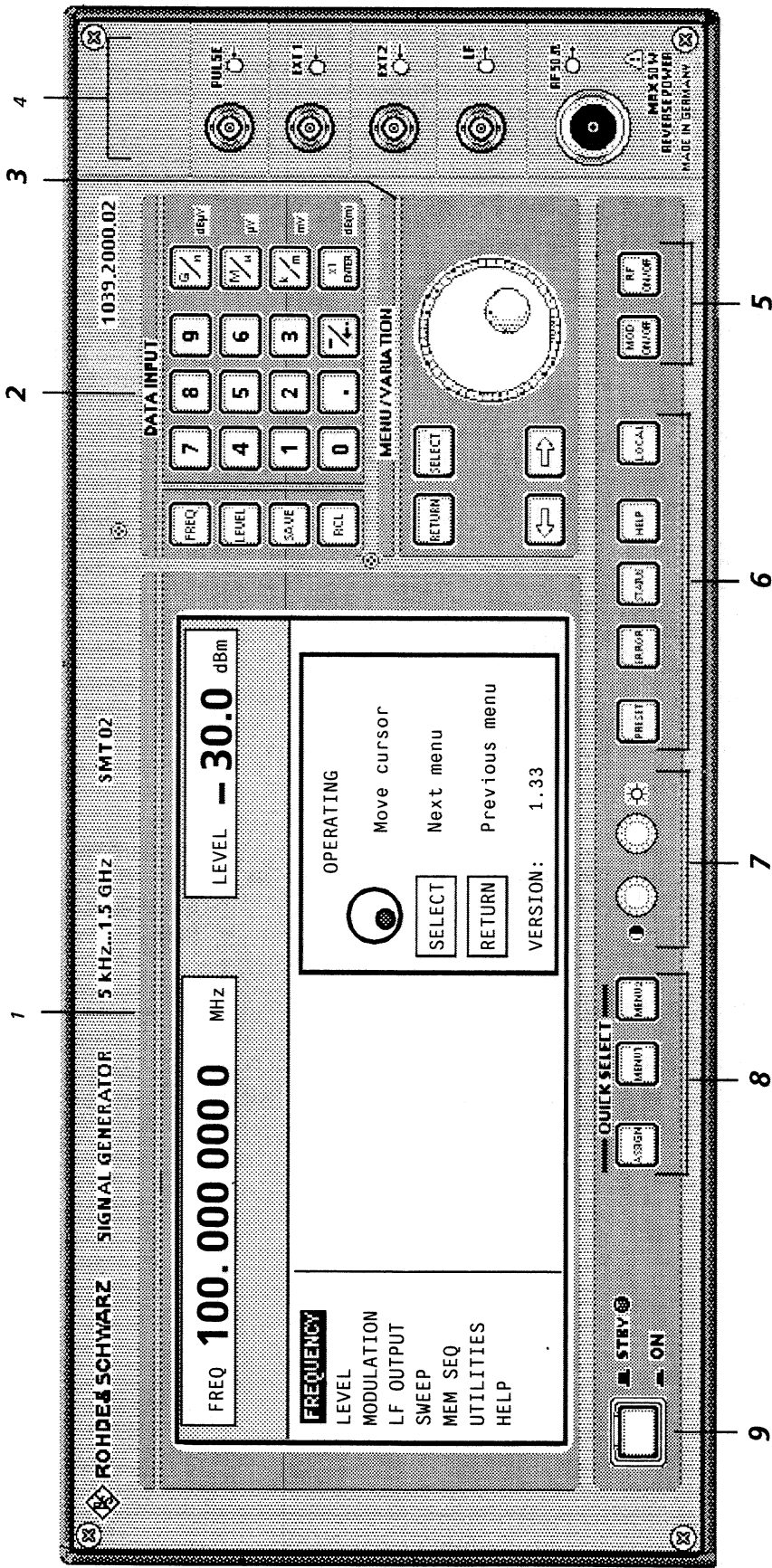
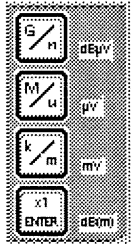

Fig. 2-1, B Front panel view, controls

2 DATA INPUT

Unit keys with enter function



The unit keys terminate the input of values and specify the multiplication factor for the respective basic unit. The basic units are displayed next to the input field while numbers are entered. In the case of level settings, the unit keys specify the unit.

G/n	dBµV	Selects Giga/nano, with RF level dBµV, with RF level dB.
M/µ	µV	Selects Mega/micro, with level µV.
k/m	mV	Selects kilo/milli, with level mV.
1x ENTER	dB(m)	Terminates entries in the basic unit and value inputs without unit. Selects with level dBm Selects with level offset and level step width dB.

In order to change to another level unit, simply press the unit key desired. Parameter LEVEL must be activated, e.g. by pressing the [LEVEL] key.

see as well
Section 2.2.2,
Basic Operating
Steps

Section 2.2.2.7,
Change Unit of Level

3 MENU VARIATION

Menu keys

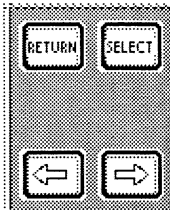

The menu keys access the menus and settings within the menus.

RETURN	Returns the menu cursor to the next higher menu level.
SELECT	Acknowledges the choice marked by the menu cursor
←	Moves the digit cursor to the left by one position in the marked value indication. Moves the menu cursor to the left by one position in a 1-out-of-n selection.
⇒	Moves the digit cursor to the right by one position in the marked value indication. Moves the menu cursor to the right by one position in a 1-out-of-n selection.

see as well
Section 2.2.2,
Basic Operating Steps

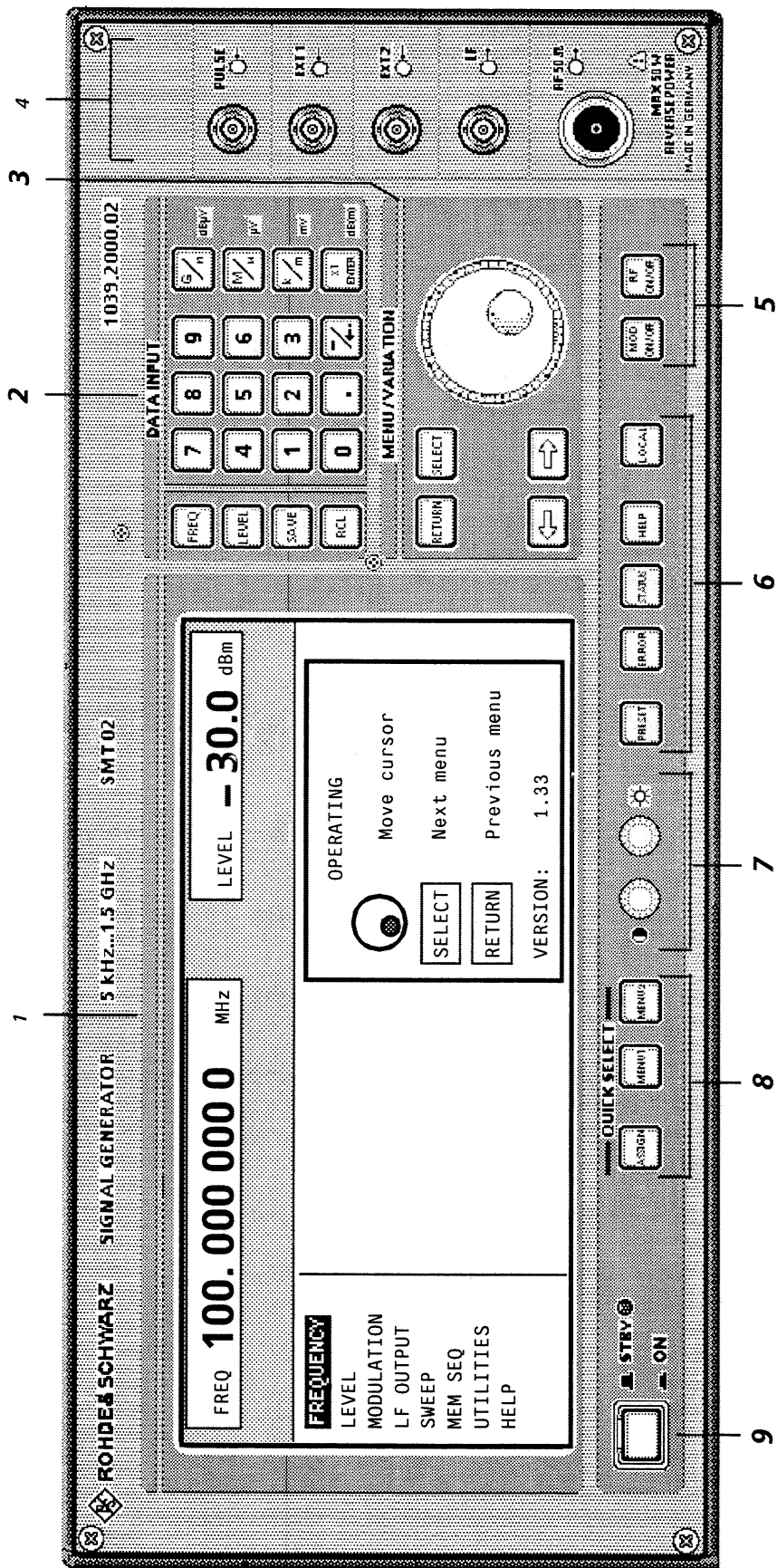
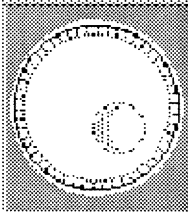

Fig. 2-1, B Front panel view, controls

3 MENU / VARIATION

Rotary knob



The rotary knob moves the menu cursor over the positions of a menu level to choose from or varies the value of a parameter. The variation is either effected in steps of one or in a step width that can be specified at will.

See as well
Section 2.2.2,
Basic Operating Steps

Section 2.2.3,
Sample Setting for
First Users

4

See Section 2.1.1.3, page 2.11, Inputs/Outputs.

5

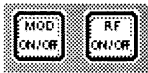

RF ON/OFF	Switches on/off the RF signal.
MOD ON/OFF	Switches on/off the modulation selected in the UTILITIES MOD KEY menu.

See as well
Section 2.2.2.6,
Use of [RF ON /OFF]
and [MOD ON /OFF]
Keys

6



PRESET	Establishes a defined instrument status.
ERROR*	Indicates error and caution messages.
STATUS*	Indicates the instrument status.
HELP*	Indicates context-sensitive auxiliary text.
LOCAL	Switches the instrument from the REMOTE mode (remote control) to the LOCAL mode (manual control).

* Exit the menus using the [RETURN] key.

See as well
Section 1.1.7,
Preset Setting

Section 2.11,
Help System

Section 2.12,
Status

Section 2.13,
Error Messages

Section 3,
Remote Control

7



Brightness and contrast of the display can be set using the rotary knobs.

	Contrast
	Brightness

See as well
Section 1.1.5, Setting
of Contrast and
Brightness of the
Display

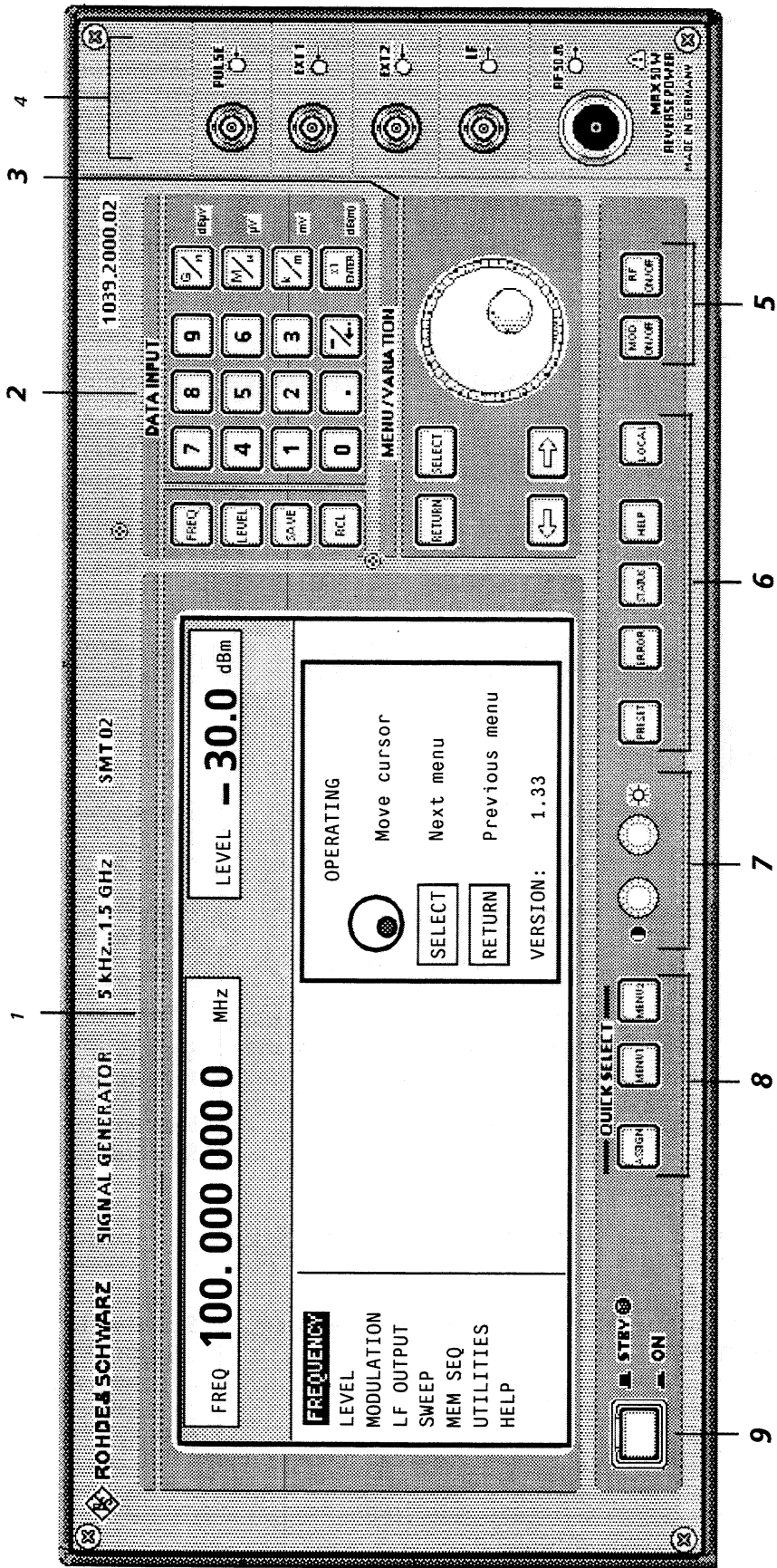

Fig. 2-1, B Front panel view, controls

7 QUICK SELECT



The menu-quick-selection keys permit fast access to two menus selected.

ASSIGN Stores the current menu as menu1 when the MENU1 key is pressed afterwards or as menu2 when the MENU2 key is pressed afterwards.

MENU1 Activates menu1 stored.

MENU2 Activates menu2 stored.

See as well
Section 2.2.2,
Basic Operating Steps

8 Switching On/Off

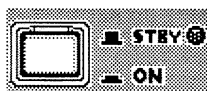

The On/Off switch switches the instrument from the standby mode to the ready-for-operation status. Prerequisite: The power switch at the rear of the instrument must be switched on.

STBY LED is illuminated in the standby mode.

See as well
Section 1.1.3,
Switching On/Off
the Instrument

Section 2.1.2,
Elements of the
Rear Panel, Power
Switch

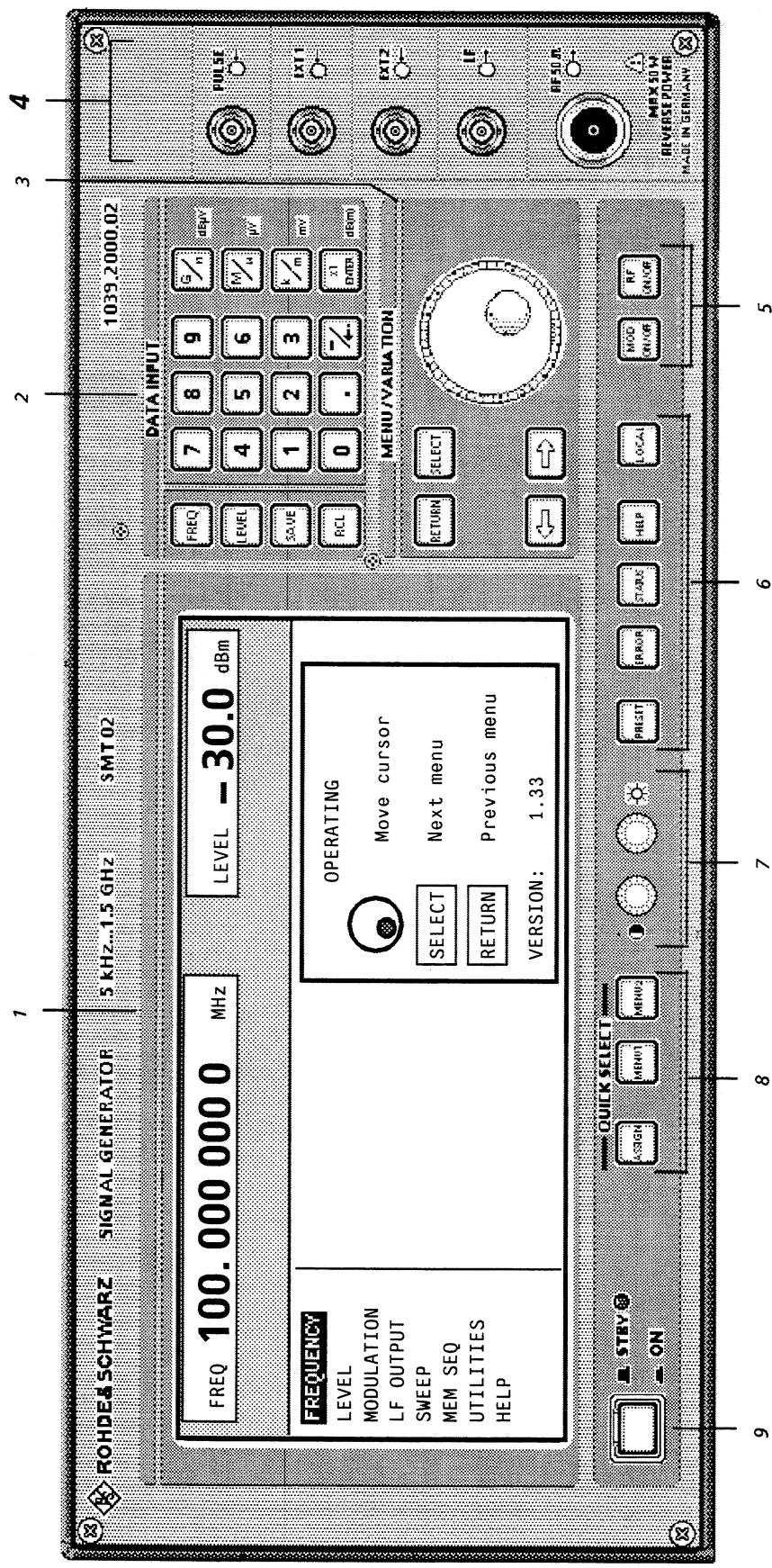

Fig. 2-1, C Front panel view, inputs/outputs

2.1.1.3 Inputs/Outputs

(Cf. Fig. 2-1, C Front panel view, Inputs/Outputs)

4

Inputs/Outputs

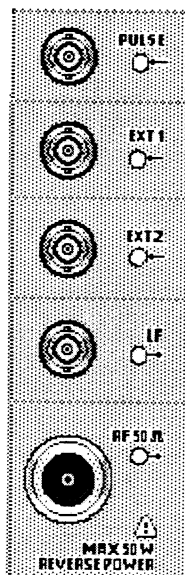

PULSE	Input* to trigger the pulse generator or to directly control the pulse modulation. Level: TTL. Input resistance 50 Ω/10 kΩ, selectable. Maximal permissible overvoltage: ± 2V	See as well Section 2.6.5, Pulse Modulation
EXT1	Input external modulation signal, alternatively for AM or FM (PM). Input resistance > 100 kΩ. Nominal voltage V_S : 1 V Maximal permissible overvoltage: ± 15V	Section 2.6.1, Modulation Sources
EXT2	Input external modulation signal for FM (PM). Input resistance > 100 kΩ. Nominal voltage V_S : 1 V Maximal permissible overvoltage: ± 15V	Section 2.6.1, Modulation Sources
LF	Output** LF-signal of the internal LF-generators LFGEN 1 and LFGEN 2. Source resistance < 10 Ω.	Section 2.7, LF output
RF	Output RF signal. Source resistance 50 Ω.	Section 2.2.2.6, Use of [RF ON / OFF] and [MOD ON / OFF] Key
*	Options: SM-B3, SM-B4, SM-B8	
**	Options: SM-B2, SM-B6	

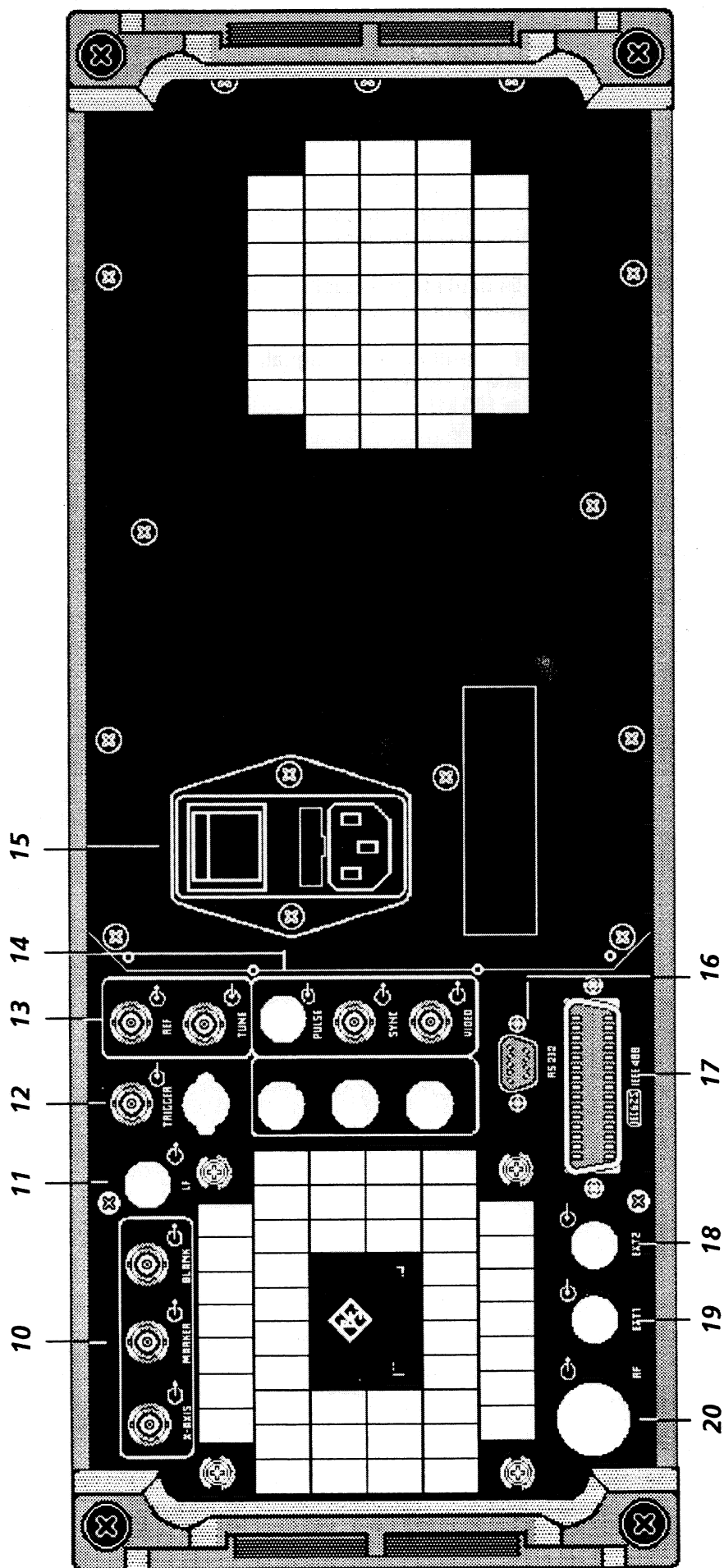

Fig. 2-2 Rear panel view

2.1.2 Elements of the Rear Panel

(Cf. Fig. 2-2, Rear panel view)

10



Outputs for control and triggering in the sweep mode.

X-AXIS Level: 0 to 10 V.

MARKER Level: TTL

BLANK Level: TTL

See as well
Section 2.8,
Sweep

11

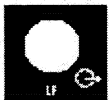

LF Cut-out, provided to relocate the LF output at the front to the rear of the instrument.

12



TRIGGER Input to trigger sweep and memory sequence.
Level: TTL

See as well
respective sections as
to menus and
Section 2.10.14,
Input/Output
Settings (AUX I/O)

13



REF Output of the internal 10-MHz reference signal with reference internal.
Source resistance 50 Ω .
Input for external reference frequency 5 or 10 MHz in operating mode external reference.
Input resistance 200 Ω .

TUNE Tuning input for the internal reference frequency. Voltage range $\pm 10V$, pulling range $\pm 1 \cdot 10^{-6}$.

See as well
Section 2.10.5,
Reference Frequency
int/ext

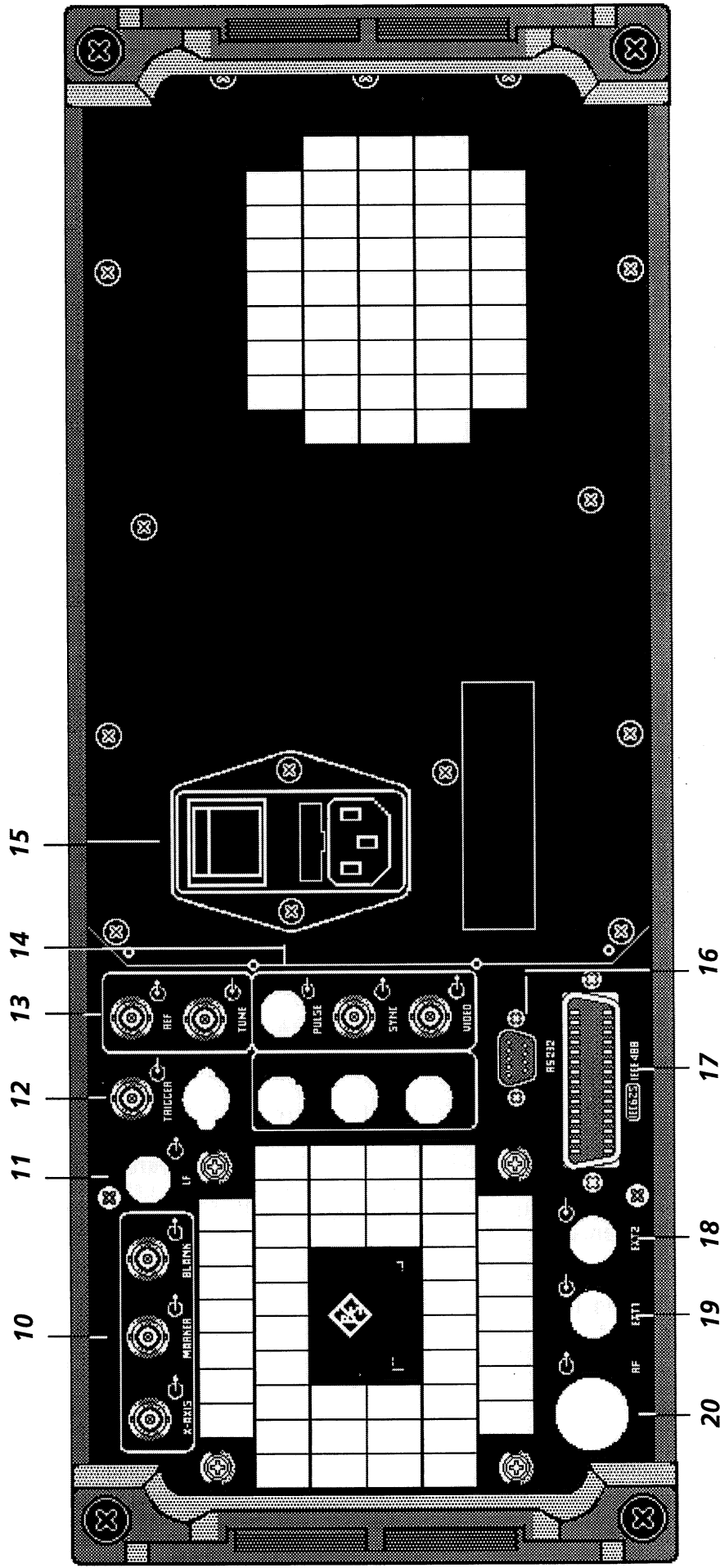

Fig. 2-2 Rear panel view



- PULSE Cut-out, provided to relocate the PULSE input at the front to the rear of the instrument.

- SYNC Output SYNC signal with pulse modulation.
Level: TTL

- VIDEO Output video signal with pulse modulation. The signal is synchronous with the RF pulse.
Level: TTL

See as well
Section 2.6.5,
Pulse Modulation

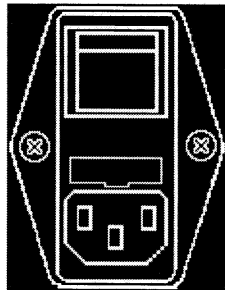

- Power switch
On when pressed at the top

- Fuse holder
F1 and F2

- Power supply connection

See as well
Section 1.1.1,
Supply Voltage
Section 1.1.2,
Power Fuses
Section 1.1.3,
Switching On/Off
the Instrument



- RS-232 RS-232 interface, used for software update and the loading of calibration data. The pin assignment corresponds to the pin assignment of a PC.

See as well
Section 3,
Remote Control

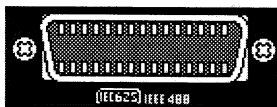

- IEC 625 IEC-Bus (IEEE 488)
IEEE 488 Remote-control interface

See as well
Section 3,
Remote Control

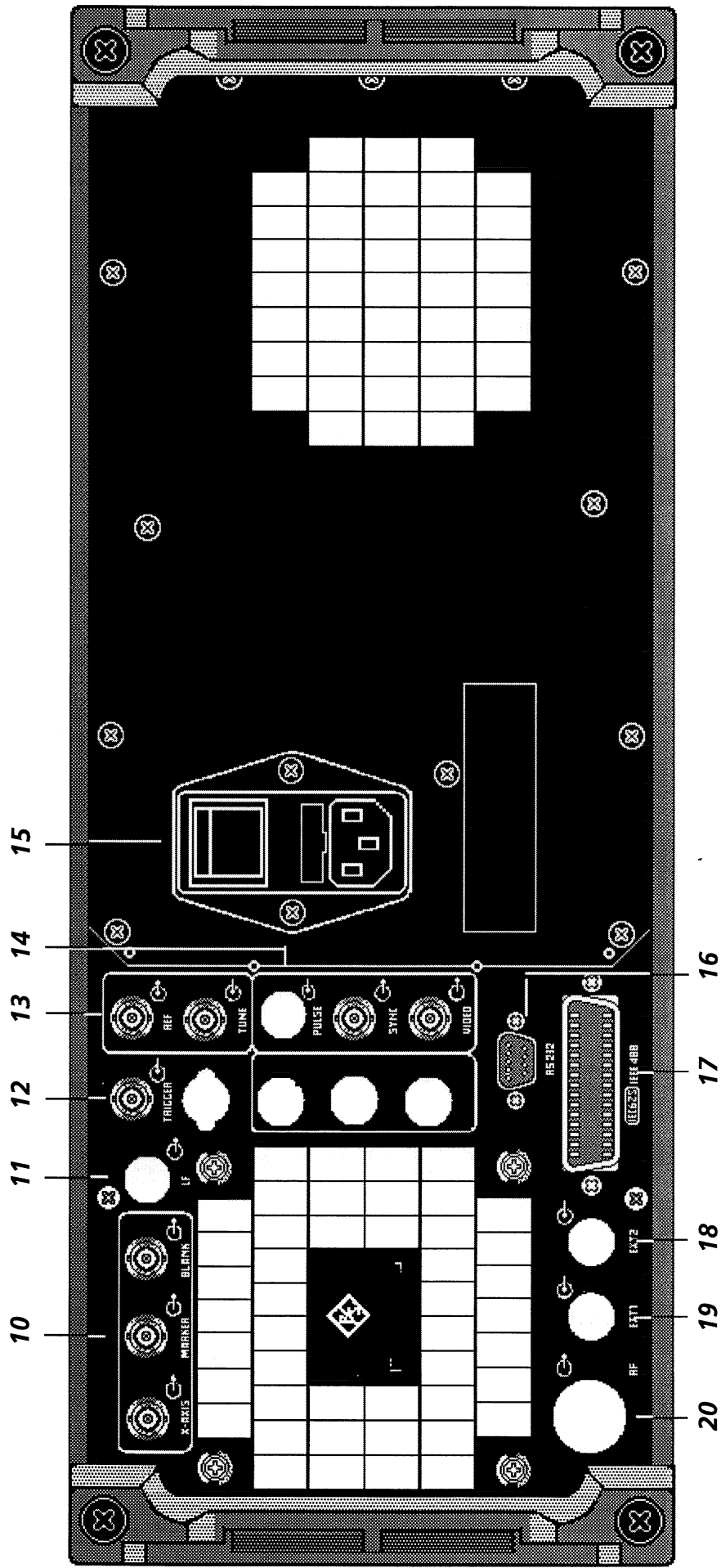

Fig. 2-2 Rear panel view



EXT2

Cut-out, provided to relocate the EXT2 input at the front to the rear of the instrument.



EXT1

Cut-out, provided to relocate the EXT1 input at the front to the rear of the instrument.



RF

Cut-out, provided to relocate the RF output at the front to the rear of the instrument.

2.2 Operating Concept

2.2.1 Display

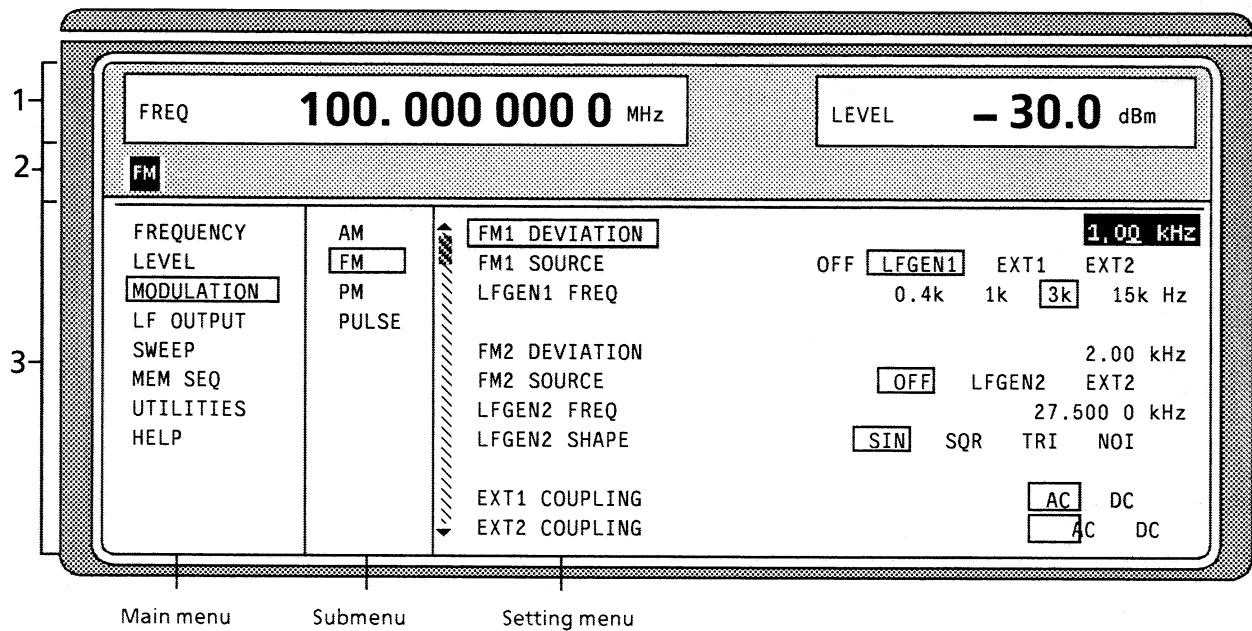

- 1 Header field
- 2 Status line
- 3 Menu fields

- Menu cursor
- Digit cursor
- Select mark

Fig. 2-3 Design of the display

Header field (1) The header field of the display indicates frequency and level of the RF output signal which considers the offset value. In the RF-sweep operating mode, the start and stop frequencies are displayed in two lines one above the other. The start and stop levels are indicated in the LEVEL-sweep operating mode correspondingly.

Status line (2) The status line below describes operating mode and operating state of the instrument. Error messages and notes for caution are also displayed in the status line.

Menu fields (3) The indication fields below the header field are reserved for the menu representations. The image contents of these fields change as a function of the menu selected. The field at the left-hand display margin is occupied with the main menu, the topmost level of the menu structure. The main menu is always faded in.

Each further field adjacent at the right contains submenus.

The field ending with the right-hand display margin shows the setting menu. In this menu all setting values and setting states connected with the menu selected are indicated. When accessing submenus, the higher-order menus remain in the display. The current menu path is evident through the select marks.

Menu cursor The menu cursor shows the user at which position in the menu he is. The position of the menu cursor is evident from the inverse notation of the term (white characters on a black background)

Digit cursor As an underscore, the digit cursor marks the position which can be varied by means of the rotary knob in a value indication.

Select mark The frame around a term marks current menus or valid settings in the setting menu.

2.2.2 Basic Operating Steps

The operating principle is explained in this section. For better understanding, please read sections "Display" (Section 2.2.1) and "Sample Setting for First Users" (Section 2.2.3) in addition.

To operate the instrument, menus are called in the display. All setting possibilities and the current setting status are evident from the menus. All settings can be made by accessing the menus.

RF frequency and RF level can also be set without menu operation using keys [FREQ] and [LEVEL]. RF signal and modulation can also be switched on/off without menu operation using keys [RF ON/OFF] and/or [MOD ON/OFF].

2.2.2.1 Calling the Menus

Accessing the menus is effected using rotary knob [VARIATION], [SELECT] key and [RETURN] key.

Rotary knob Rotary knob [VARIATION] moves the menu cursor over the positions of a menu level to be selected.

If a scrollbar is visible at the left-hand margin of a menu, the menu is larger than the screen window. If the menu cursor is moved to the margin of the screen window, the covered lines become visible.

[SELECT] key The [SELECT] key acknowledges the selection marked by means of the menu cursor.

[RETURN] key The [RETURN] key

- returns the menu cursor to the next higher menu level.
The menu cursor is shifted to the left into the preceding column of the menu structure.
- resets the menu cursor from frequency or level value indication in the header field into the menu field to the menu called last.
- closes the display pages called using keys [STATUS], [HELP] and [ERROR] again.

Settings are accessed in the setting menus ending with the right-hand display margin.

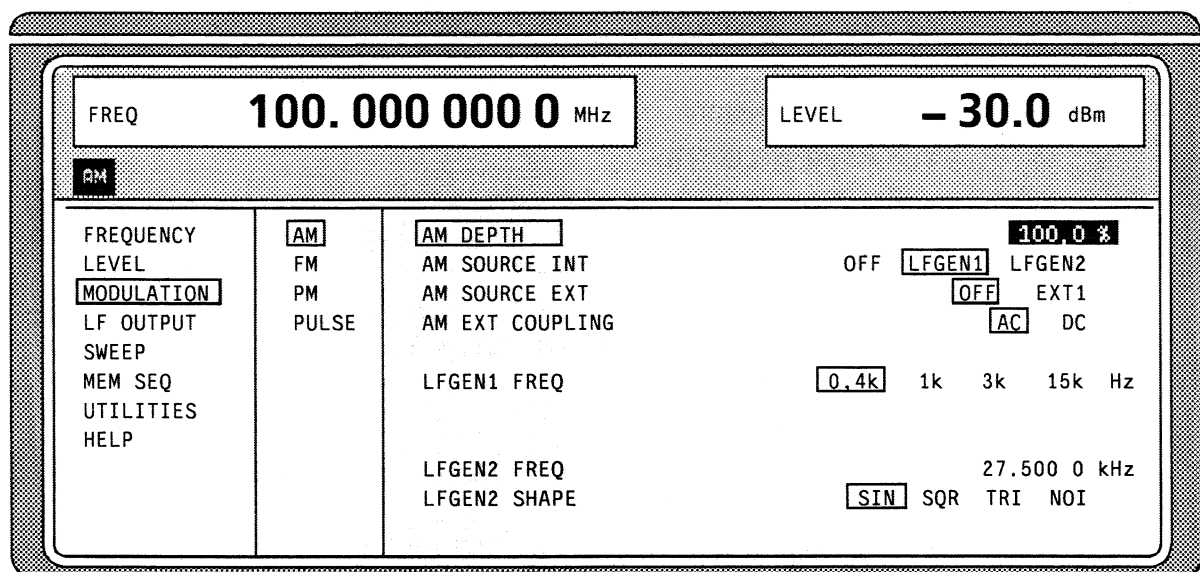

Fig. 2-4 MODULATION-AM menu

2.2.2.2 Selection and Change of Parameters

Select

parameter

- ▶ Set the menu cursor to the name of the parameter desired using the rotary knob, e.g. to AM DEPTH in the AM menu, Fig. 2.4.

Change setting value

via value inputs

- ▶ Press the first digit of the new value or minus sign.
The old value is deleted, the entry is indicated in the marked field.
- ▶ Enter further digits.
- ▶ Terminate the input using a unit key or, in the case of inputs in the base unit or in the case of inputs without unit, using the [1x/Enter] key.
- ▶ Press the [RETURN] key.
The menu cursor wraps back to the appropriate parameter.

using rotary knob

- ▶ Press the [SELECT] key.
The menu cursor changes from the parameter selected in the left-hand column of the setting menu to the setting value on the right, e.g. from AM DEPTH to 100%, Fig. 2-4.
- ▶ Set the underscore to the position of the setting value to be varied using keys [→] [←].
- ▶ Turn the rotary knob.
The position underscored is varied in steps of 1.

Note: *RF frequency and RF level can also be varied in a step width which can be defined arbitrarily using the rotary knob. In the respective setting menu (FREQUENCY or LEVEL) the step width is entered as KNOB STEP USER and the KNOB STEP set from DECIMAL to USER. To point to the fact that the step width has been converted to the value programmed, the underscore as a symbol of the digit cursor disappears in the respective value indication.*

1-out-of-n selection

- ▶ Select parameters.
- ▶ Press the [SELECT] key.
The menu cursor changes from the parameter selected in the left-hand column of the setting menu to the current selection on the right, e.g. from LFGEN1 FREQ to 0.4 kHz, Fig. 2-4.
- ▶ Set the menu cursor to the position desired within the 1-out-of-n selection using the rotary knob or cursor keys [→] [←].
- ▶ Press the [SELECT] key.
The setting is made.
The selection mark which has marked the setting valid up to now wraps to the new position.
- ▶ Press the [RETURN] key.
The menu cursor wraps back to the respective parameter.

Quick selection of a parameter

The quick selection of a parameter reduces the number of operating steps if several parameters are set successively. The menu cursor can directly be set further from line to line in the column of the setting values.

- ▶ Press the [SELECT] key.

The menu cursor wraps from the setting value of a parameter to the setting value of the parameter in the next line.

The following

- is true:
- The column of the setting values can be exited at each position by pressing the [RETURN] key.

2.2.2.3 Triggering Action

Lines in the setting menu which are marked with the "▶" symbol at the end of the line qualify an action which can be carried out. Instruction SEARCH ONCE ▶ in the LEVEL-ALC menu, e.g., switches on level control for level calibration for a short period of time.

Trigger action

- ▶ Set the menu cursor to the respective instruction.

- ▶ Press the [SELECT] key.

The action is triggered.

While the action is carried out, the instruction remains framed by the selection mark.

2.2.2.4 Quick Selection of Menu (QUICK SELECT)

The keys of the QUICK SELECT control field are used to call selected menus quickly by one keystroke.

Store menus

- ▶ Establish the desired operating status of the current menu.

- ▶ Press the [ASSIGN] key.

- ▶ Press key [MENU1] or [MENU2].

The current menu is stored as menu1 or menu2. That is to say, 2 menus can be stored in total.

Call menus

- ▶ Press key [MENU1] or [MENU2].

Menu1 or menu2 stored is displayed. Exactly the operating status which was current at the point of time of storing is reconstructed.

2.2.2.5 Use of [FREQ] and [LEVEL] Keys

RF frequency and RF level can be set without menu operation as well using direct keys [FREQ] and [LEVEL]. The input value considers the offset, see Sections 2.4 and 2.5.

- Key [FREQ]/ [LEVEL]**
- ▶ Press the [FREQ] or [LEVEL] key.
 - The frequency and/or the level indication in the header field of the display is marked.
 - The current menu at the display is maintained.
 - ▶ Alter the value via a value input or the rotary knob.
 - ▶ Press the [RETURN] key.
 - The menu cursor wraps to the position marked last in the menu.

2.2.2.6 Use of [RF ON / OFF] and [MOD ON / OFF] Keys

RF signal and modulation can be switched on/off without menu operation as well using direct keys [RF ON / OFF] and/or [MOD ON / OFF] (see Section 2.6.1.3, [MOD ON/OFF] key as well).

- Key [RF ON / OFF] /**
- ▶ Press the [RF ON / OFF] key.
 - The RF output signal is switched on/off.
 - IEC--bus short command: : *OUTP OFF*
- Key [MOD ON / OFF]**
- ▶ Press the [MOD ON / OFF] key.
 - ▶ A direct IEC-bus command is not available. The modulations have to be switched on/off on and off in the respective modulation submenus.

2.2.2.7 Changing Unit of Level

For the level, the unit of the value set can be changed without a new value input.

- Change level unit**
- ▶ Activate LEVEL parameter.
 - Press the [LEVEL] key or
 - set the menu cursor in the LEVEL menu to the setting value of the AMPLITUDE parameter.
 - ▶ Press the unit key with the desired level unit.
 - The level is indicated in the desired unit.

2.2.2.8 Correction of Input

Digital entries can be corrected by one of the Unit/Enter keys before terminating the input.











- Key [- /←]** The backspace key deletes the value entered digit by digit. When the last digit is deleted, the previous value is displayed.
- Key [RETURN]** Pressing the [RETURN] key deletes the entire entry and results in the previous value being indicated again.
For a subsequent new input in the setting menu, the first digit of the new value is to be entered.
For a subsequent new input via the [FREQ] or [LEVEL] keys, the respective key has to be pressed again.
- Key [FREQ]/ [LEVEL]** In the case of a frequency or level input by means of the [FREQ] or [LEVEL] keys, pressing the [FREQ] and/or [LEVEL] key again deletes the entire input.

2.2.3 Sample Setting for First Users

First users most quickly become familiar with the operation of the instrument if they execute the pattern setting of this section.





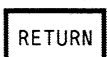



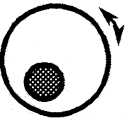

First frequency and level of the RF output signal are set via keys [FREQ] and [LEVEL] in the DATA INPUT field:

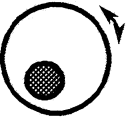
- Frequency 250 MHz
- Level 10 dBm

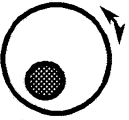
Operating steps	Explanations
	Reset the instrument to the defined state.
    	Set the frequency to 250 MHz. The menu cursor marks the permanent frequency indication.
   	Set the level to 10 dBm. The menu cursor marks the permanent level indication.
	Reset the menu cursor to the menu field.

The output signal is to be amplitude-modulated next.

- AM modulation depth 15.5 %
- AM signal 3-kHz sine

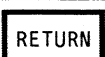
Operating steps	Explanations
 MODULATION 	Select MODULATION menu. ▶ Set menu cursor to MODULATION using the rotary knob and subsequently press [SELECT] key. The submenu is displayed.
 AM 	Select AM submenu. The AM setting menu is displayed.
 AM DEPTH 	Select AM DEPTH parameter. The menu cursor marks the setting value .
    	Enter modulation depth 15.5% and acknowledge.
	Reset menu cursor to AM DEPTH.

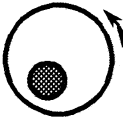
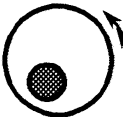
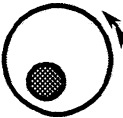
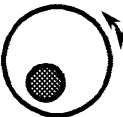
Operating steps	Explanations
 AM SOURCE INT <input type="checkbox"/> SELECT	Select AM SOURCE INT. The menu cursor marks the current 1-out-of-n selection.
 . LFGEN1 . <input type="checkbox"/> SELECT	Select LF generator1 as modulation source. The selection mark marks LFGEN1. AM is faded in the status line as a hint that AM is switched on.
<input type="checkbox"/> RETURN	Reset menu cursor to AM SOURCE INT.
 LFGEN1 FREQ <input type="checkbox"/> SELECT	Select parameter LFGEN1 FREQ. The menu cursor marks the current frequency selection.
 . 3k . <input type="checkbox"/> SELECT	Set the frequency of LF generator1 to 3 kHz. The selection mark marks 3 kHz. The indications on the display are represented in Fig. 2-5.

The AM modulation setting is completed.

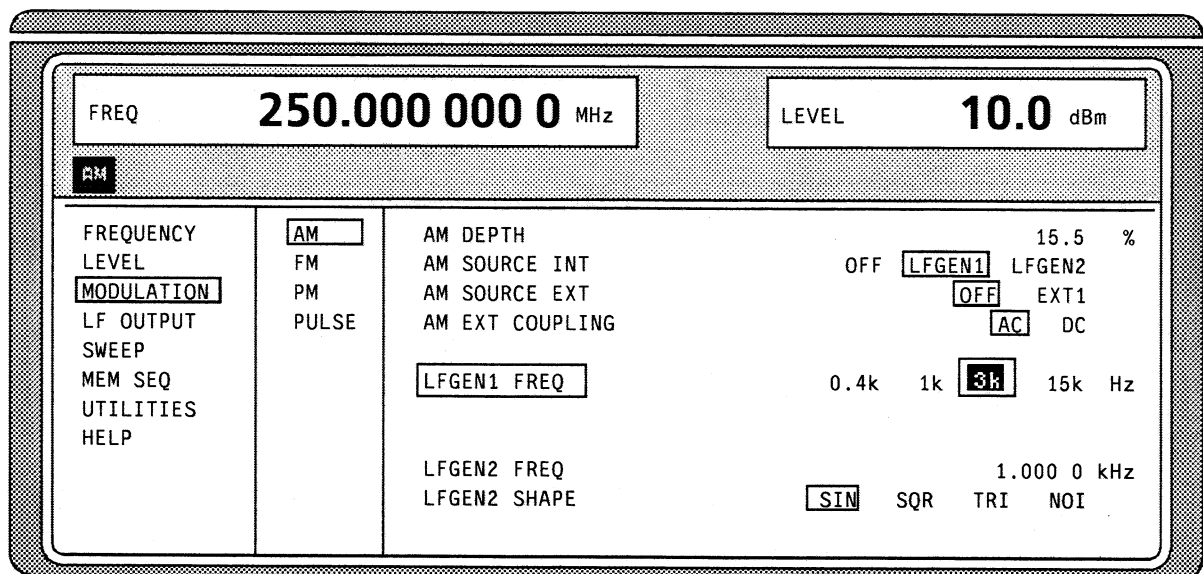

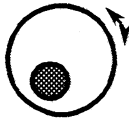

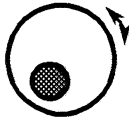

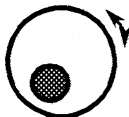
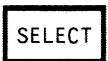















Fig. 2-5 Display after AM setting

Subsequently to the above setting, 420 MHz as new RF frequency and 12.5 kHz as the step width for the RF frequency variation are set in the following. Parameter quick select is used, which reduces the number of operating steps.

Operating steps	Explanations
  	Reset the menu cursor to the main menu in 3 steps.
 FREQUENCY 	Select FREQUENCY menu. The frequency setting menu is displayed.
 FREQUENCY 	Select FREQUENCY parameter. The menu cursor marks the setting value.
   	Enter frequency 420 MHz and acknowledge.
 	Set menu cursor to the setting value of parameter KNOB STEP USER.
    	Enter step width 12.5 kHz.
	Set menu cursor to the current KNOB STEP selection.
 . USER . 	Select USER (user-defined step width) The selection mark marks USER. This results in step width 12.5 kHz being used in the case of variation using the rotary knob.



Bild 2-6 Display after pattern setting

2.2.4 List Editor

The SMT offers the possibility of generating lists. Lists are used for setting sequences (memory sequence) or for level correction which can be defined by the user (UCOR). They consist of elements which are defined by an index and at least one parameter per index. Each list is marked by a separate name and can be selected via this name. The lists are accessed in the menus assigned in each case, e.g. to the settings sequences of stored instrument settings in the MEM SEQ menu. However, the lists are always generated and processed in the same way and the procedures are hence explained in detail by the example of the memory sequence mode (menu MEM SEQ) in this section. A pattern setting at the end of this section allows the user to become familiar with the operation of the list editor.

Setting menus providing list processing are structured in two pages:

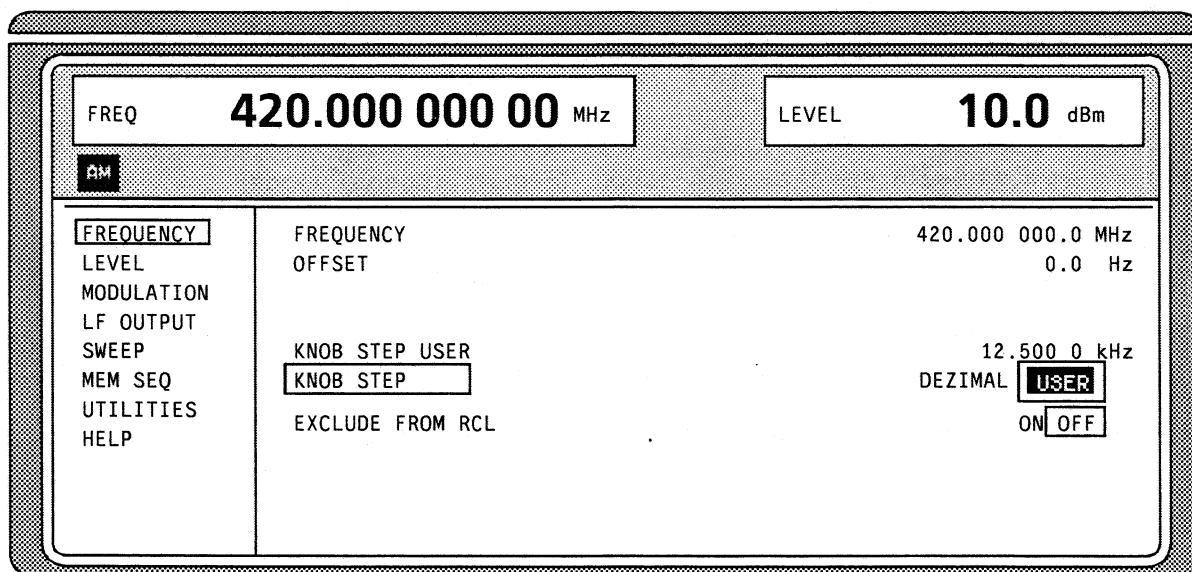
The first page, called OPERATION page in the following contains the general configuration parameter for processing a list. Further, the general list functions such as selecting and deleting the list as well as calling an editing mode are provided. The second page, the EDIT page, is automatically displayed when calling an edit function and serves to enter and modify the parameters of the list.

The OPERATION page has a similar arrangement with all list editors. As an example, the OPERATION page of the MEM SEQ menu is shown:

Menu selection: MEM SEQ

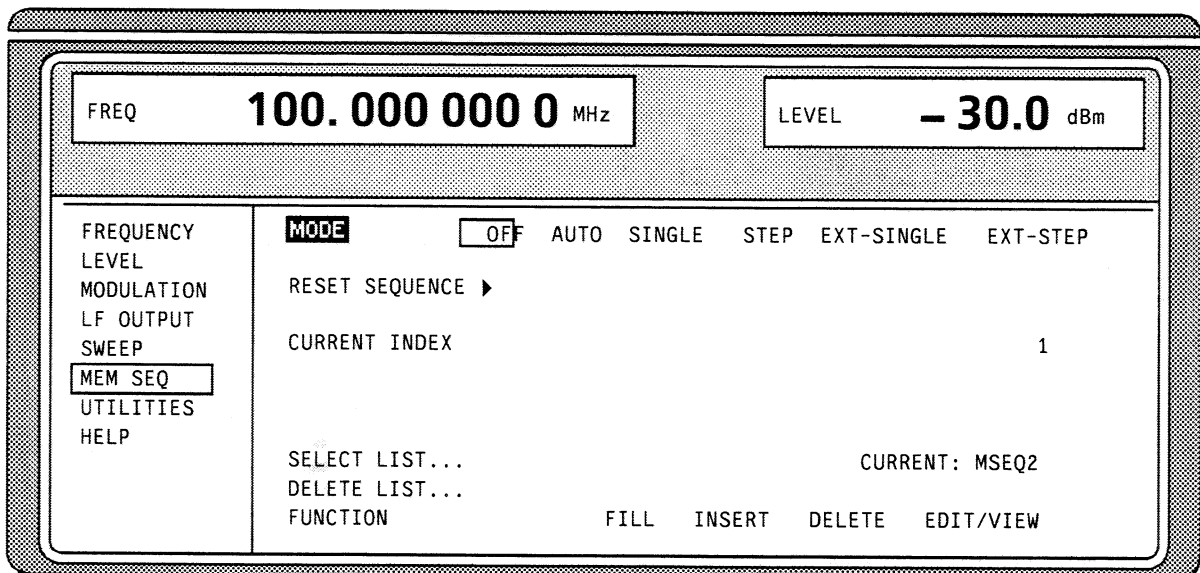

Fig. 2-7 OPERATION page of the MEM SEQ menu

The settings for MODE, CURRENT INDEX, etc. are irrelevant for the general description of the list editors and are described in greater detail in Section "Memory Sequence" mode.

The last three menu lines of the OPERATION page always exist and are reserved for selecting and deleting lists as well as for calling the edit functions (and hence the EDIT page).

SELECT LIST Opens a selection window in which a list can be selected from the existing lists or a new, empty list can be generated. In this line the active list is always displayed.

DELETE LIST Opens a selection window in which the list to be deleted can be selected.

FUNCTION	Selection of the edit function for processing the lists. The EDIT page is automatically called through the selection (cf. Section 2.2.4.3).
FILL	Filling a list with elements.
INSERT	Insertion of elements into a list.
DELETE	Deletion of elements of a list.
EDIT/VIEW	Processing the individual elements.

2.2.4.1 Select and Generate List — SELECT LIST

SELECT LIST opens a selection window in which either an existing list can be selected or a new, empty list can be generated (cf. Fig. 2-8). By pressing the [RETURN] key, the selection window is closed without changing the setting.

- Select list
- ▶ Mark the list desired using the rotary knob.
 - ▶ Press [SELECT] key.
The selected list is included in the instrument setting. The selection window is closed. The selected list is displayed under CURRENT.
- Generate list
- ▶ Mark CREATE NEW LIST ▶ using rotary knob.
 - ▶ Press [SELECT] key.
A new empty list is automatically generated which can be filled using functions FILL or EDIT. The selection window is closed. The new list is displayed under CURRENT.
- No modification of the setting
- ▶ Press [RETURN] key.

Selection: SELECT LIST

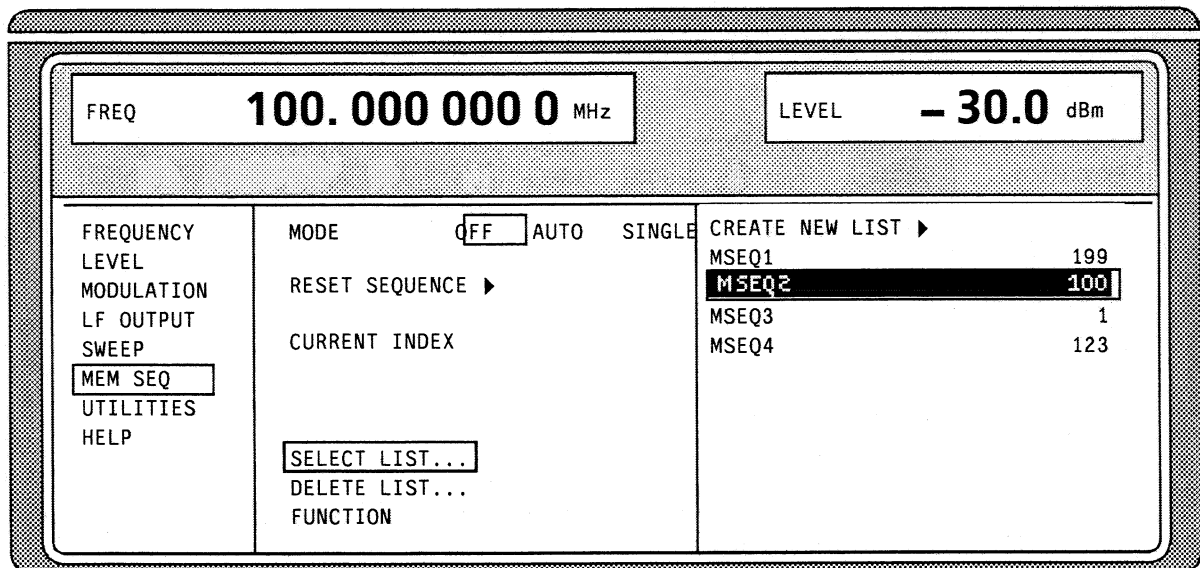

Fig. 2-8 SELECT-LIST selection window

CREATE NEW LIST ▶

Generating a new list. The name of the list cannot be selected freely in the case of manual control. A definite list name is automatically generated in the following form:

MSEQ<n>, with <n> ∈ {0..9}, e.g. MSEQ1 (with memory sequence).

This applies correspondingly to the other operating modes. In the case of level correction, UCOR1 would be generated for example. If a list is created via IEC bus, an arbitrary list name can be given (cf. Section 3). Unrestricted access is also possible by means of the selection window.

MSEQ2 100

The list currently set is marked in the selection window by means of the selection mark, here MSEQ2. In addition to the list name, the length of the list is given, here 100 elements.

2.2.4.2 Deletion of Lists – DELETE LIST

DELETE LIST opens a selection window in which the list to be deleted can be selected. The lists are represented together with their name and their length (cf. Fig. 2-9). By pressing the [RETURN] key the selection window is exited without deleting a list.

Delete list

- ▶ Mark desired list using the rotary knob.
- ▶ Press [SELECT] key.
The prompt "enter [SELECT] to delete list/sequence" is displayed
- ▶ Press [SELECT] key.
The list is deleted. If the prompt is acknowledged with the [RETURN] key, however, the list is not deleted. The selection window is automatically closed due to the acknowledgement of the prompt.

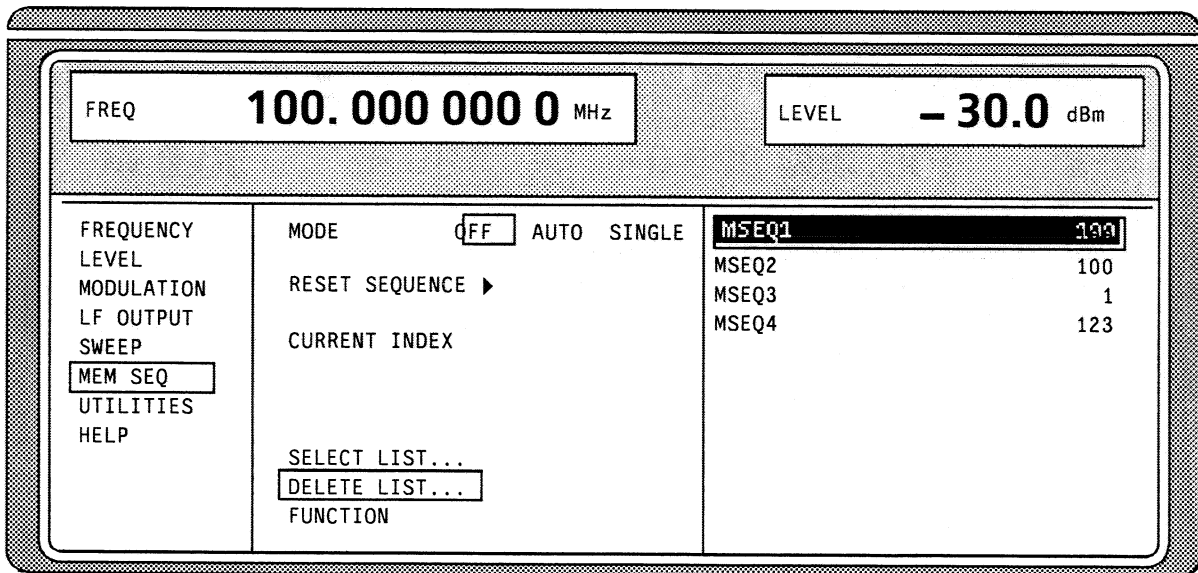

Fig. 2-9 DELETE-LIST selection window

2.2.4.3 Edition of Lists

Due to the selection of an edit mode on the OPERATION page the EDIT page is automatically activated. When the EDIT/VIEW function is selected, the largest possible section of the list is displayed (cf. Fig. 2-10). In the case of block functions FILL, INSERT and DELETE, an input window is additionally displayed (cf. Fig. 2-11 to 2-13).

Functions SELECT LIST and FUNCTION are available on the EDIT page as on the OPERATION page.

Return to the OPERATION page is effected by pressing the [RETURN] key twice.

Single-value function EDIT/VIEW

By selecting the EDIT/VIEW function, the entire list can be viewed or modifications of single values be carried out.

If the cursor marks a value in the INDEX column of the list, the EDIT mode is exited by pressing the [RETURN] key. The menu cursor then marks FUNCTION again.

There is no separate function for storing the list. This means that every modification of the list is transferred to the internal data set and has an effect on exiting the EDIT/VIEW function.

Selection: FUNCTION EDIT/VIEW

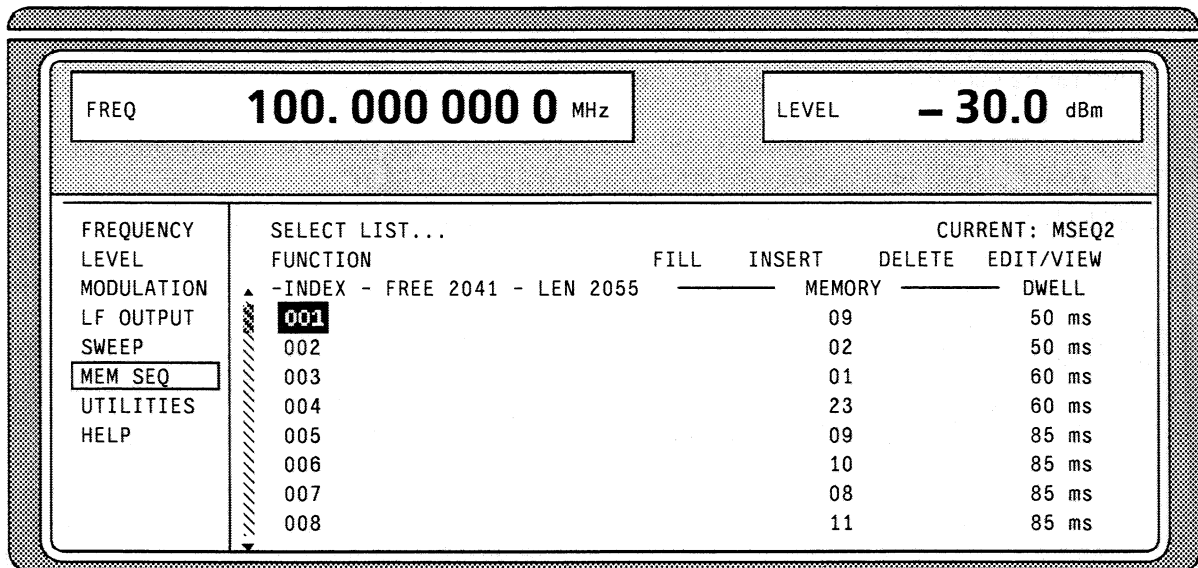

Fig. 2-10 Edit function EDIT/VIEW

INDEX Identification of the column below, here position in the list.

FREE Space available. FREE 2041 means that space for 2041 parameter elements is available in the list memory in total.

LEN Occupied space. LEN 2055 means that the current list occupies 2055 elements in the list memory.

MEMORY Identification of the column below, here memory location number.

DWELL Identification of the column below, here dwell time

- Select parameters
 - ▶ Mark the index associated to the parameter using the rotary knob or directly enter the value of the index via the numeric keys.
 - ▶ Press [SELECT] key.
Parameter MEMORY is marked. If the second parameter DWELL is to be marked, press the [SELECT] key again.

- Modify parameters
 - ▶ Vary the value of the parameter selected using the rotary knob or enter the value directly using numeric keys.
 - ▶ Press the [ENTER] key or unit keys.
The value is included in the data set. The menu cursor marks the value of the next column. In the last column, the menu cursor then marks the next line of column MEMORY.
 - ▶ Press the [RETURN] key.
The menu cursor wraps back to the INDEX column. The EDIT mode is exited by repeatedly pressing the [RETURN] key (cf. Section 2.2.4.4).

Block function FILL

Using function FILL, a parameter, e.g. MEMORY, is overwritten with constant or linearly increasing/decreasing values within a defined range. The input window is exited by pressing the [RETURN] key without a modification being carried out.

If the filling range exceeds the end of the list, the list is automatically extended.

The list entry, in the example for MEMORY, with index [AT + n] is calculated as follows from the information AT, RANGE, starting value (MEMORY) and WITH INCREMENT:

$$\text{MEMORY[AT + n]} = \text{starting value (MEMORY)} + n \cdot \text{increment} \quad | \quad (0 \leq n \leq \text{RANGE} - 1)$$

Selection: FUNCTION-FILL

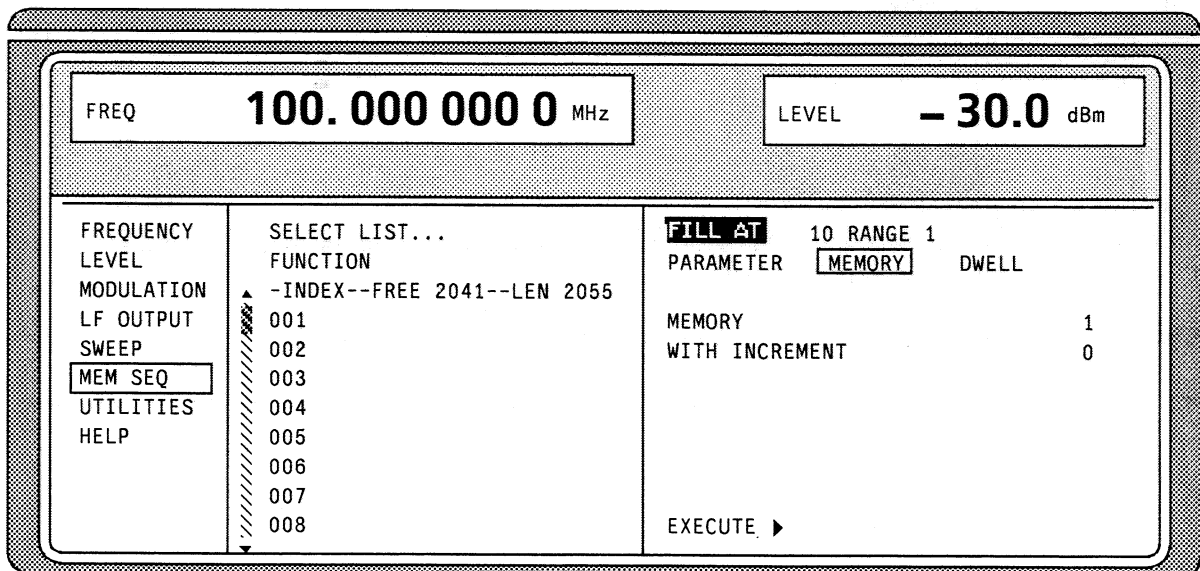

Fig. 2-11 Block function FILL: Input window

FILL AT	Setting the filling range. AT Lower limit (index) RANGE Number of elements to be filled.
PARAMETER	Selection on which of the parameters the filling function is to have an effect. This menu option is eliminated if the list only includes elements with one parameter.
MEMORY or DWELL	Input of the starting value for the parameter selected. This option is only displayed if a selection has been made under PARAMETER MEMORY or DWELL.
WITH INCREMENT	Input of the increment between two successive values. If 0 is entered as increment, a filling procedure with constant values is achieved. This option is only displayed if a selection has been made under PARAMETER MEMORY or DWELL.
EXECUTE ▶	Starts the filling sequence. After the function has been executed, the input window is automatically exited. The current index points to the first element after the processed range..

- Filling a list
- After selection of function FILL, the menu cursor marks FILL AT.
- ▶ Press the [SELECT] key.
The menu cursor marks the value at AT.
 - ▶ Vary index value using the rotary knob or enter using the numeric keys and the [ENTER] key.
 - ▶ Press the [SELECT] key.
The menu cursor marks the value at RANGE.
 - ▶ Vary value using the rotary knob or enter using the numeric keys and the [ENTER] key.
 - ▶ Press the [SELECT] key.
The menu cursor marks MEMORY or DWELL in input line PARAMETER.
 - ▶ Select MEMORY using the rotary knob (if not yet marked) and press the [SELECT] key.
The menu cursor marks the value in input line MEMORY.
 - ▶ Vary starting value for column MEMORY using the rotary knob or enter using the numeric keys and the [ENTER] key.
 - ▶ Press the [SELECT] key.
The menu cursor marks the value in input line WITH INCREMENT.
 - ▶ Vary the value of the increment desired using the rotary knob or enter using the numeric keys and the [ENTER] key.
 - ▶ Press the [RETURN] key.
 - ▶ Mark the action EXECUTE ▶.
 - ▶ Press the [SELECT] key.
The filling sequence is initiated. After the function has been carried out, the input window is automatically exited. The menu cursor marks FUNCTION. The EDIT page shows the end of the range that has been filled right now.

Block function INSERT

Function INSERT inserts the desired number of elements with constant or linearly increasing/decreasing values before the element with the given starting index. All elements which had been stored from the starting index are shifted to the end of the range to be inserted.

Input is effected analogously to filling a list.

By pressing the [RETURN] key the input window is exited without a modification being effected. The menu cursor then marks FUNCTION.

The list entry, in the example for MEMORY, with index [AT + n] is calculated as follows from the information AT, RANGE, starting value (MEMORY) and WITH INCREMENT:

$$\text{MEMORY}[AT + n] = \text{starting value (MEMORY)} + n \cdot \text{Increment} \quad | \quad (0 \leq n \leq \text{RANGE} - 1)$$

Selection: FUNCTION INSERT:

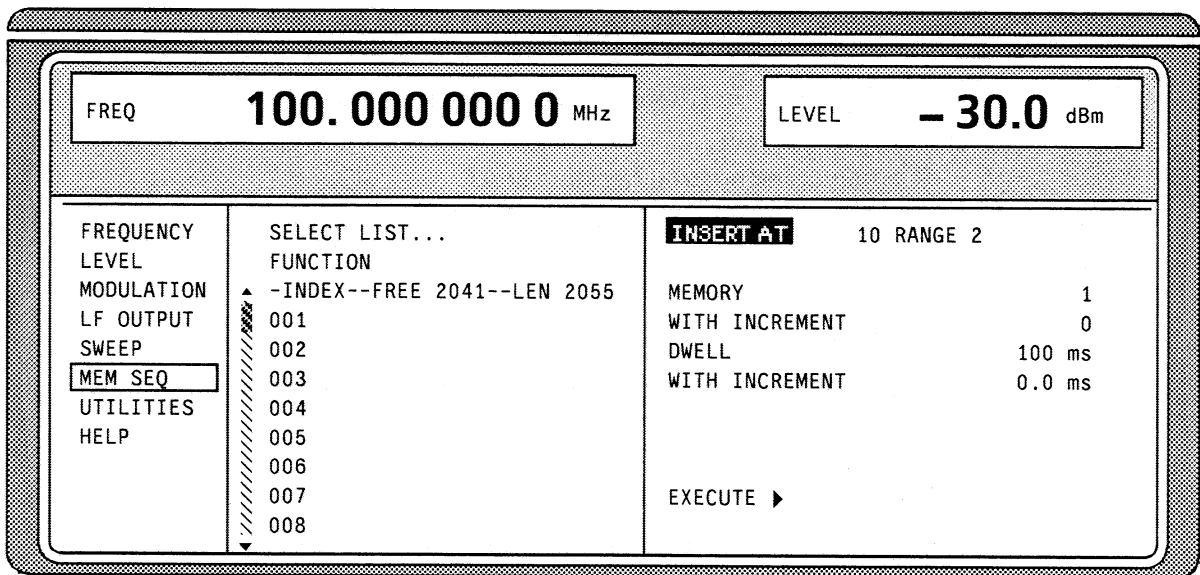

Fig. 2-12 Edit function INSERT: Input window

- INSERT AT** Input of the starting index and the number of the elements to be inserted.
 AT Starting index before which the insert operation is to be effective.
 RANGE Number of the elements to be inserted
- MEMORY** Input of the starting value for MEMORY.
- DWELL** Input of the starting value for DWELL.
- WITH INCREMENT** Input of the increment between two successive values for MEMORY or DWELL. If 0 is indicated as increment, constant values are achieved to be inserted RANGE times.
- EXECUTE ▶** Starts the inserting sequence. After the function has been executed, the input window is automatically exited. The menu cursor marks FUNCTION. The EDIT page shows the beginning of the range that has moved forward.

Block function DELETE

Function DELETE deletes the elements of the range indicated. This does not leave a gap in the list but the remaining elements move forward. If the given range exceeds the end of the list, deletion until the end of the list is effected.

Input is analog to filling a list.

By pressing the [RETURN] key, the input window is exited without a modification being carried out. The menu cursor then marks FUNCTION.

Selection: FUNCTION DELETE

The screenshot shows a terminal-style interface for editing the 'DELETE' function. At the top, there are two fields: 'FREQ' with the value '100.000 000 0 MHz' and 'LEVEL' with the value '- 30.0 dBm'. Below these is a list of functions: 'FREQUENCY', 'LEVEL', 'MODULATION', 'LF OUTPUT', 'SWEEP', 'MEM SEQ' (highlighted with a box), 'UTILITIES', and 'HELP'. To the right of this list is a vertical scroll bar. Further right, the text 'SELECT LIST...' and 'FUNCTION' is displayed, followed by '-INDEX--FREE 2041--LEN 2055'. Below this is a list of indices from 001 to 008. To the right of this list is the text 'DELETE AT' followed by '10 RANGE 2'. At the bottom right, there is an 'EXECUTE' button with a right-pointing arrow.

Fig. 2-13 Edit function DELETE: Input window

DELETE AT Input of the block of the list to be deleted
AT Lower limit (INDEX)
RANGE Number of elements to be deleted.

EXECUTE ► Starts the deletion. After the function has been executed, the input window is automatically exited. The menu cursor marks FUNCTION. The EDIT page shows the beginning of the range that has moved forward.

2.2.4.4 Pattern Setting to Operate the List Editor

The user can become familiar with the operation of the list editor by means of the following pattern setting in the MEM SEQ menu. A list has to be generated and filled with values by using the single-value function EDIT/VIEW:

- Memory location number of the first element 20
- Dwell time of the first element 15s
- Memory location number of the second element 1.

When the setting has been terminated, return to the OPERATION page of the MEM SEQ menu.

At the beginning of the operation sequence, menu MEM SEQ is called. List MSEQ2 is active. The menu cursor marks a parameter of the setting menu on the OPERATION page (c.f. Fig. 2-14).

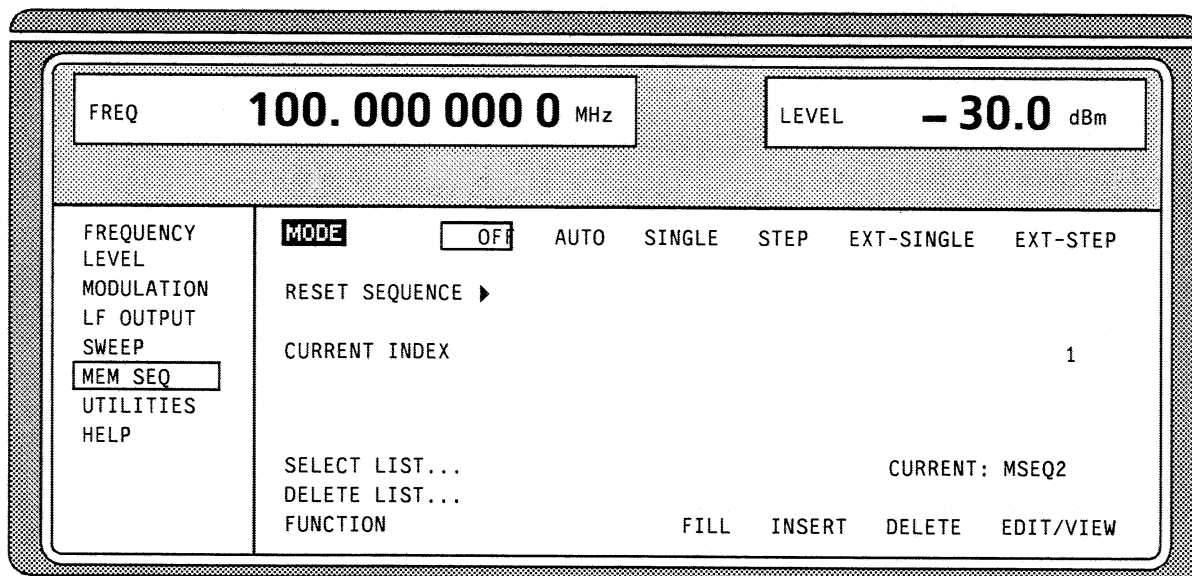
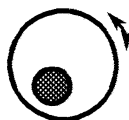

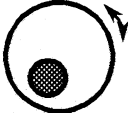
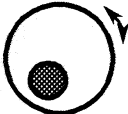

Fig. 2-14 Starting point of the pattern setting

Operating steps		Explanations
	. SELECT LIST... .	Select the SELECT LIST menu item.
	. CREATE NEW LIST	A new list MSEQ0 is generated. The menu cursor is reset to SELECT LIST....

Operating steps	Explanations
 FUNCTION <input type="button" value="SELECT"/>	Select the FUNCTION menu item.
 . EDIT/VIEW . <input type="button" value="SELECT"/>	Select single-value function EDIT/VIEW. The EDIT page of the MEM SEQ menu is called. The menu cursor marks the index of the first element of list MSEQ0.
<input type="button" value="SELECT"/>	Set the menu cursor to the memory location number value of the first element (c.f. Fig. 2-15,A).
<input type="button" value="2"/> <input type="button" value="0"/> <input type="button" value="1x ENTER"/>	Enter MEMORY 20. The menu cursor automatically wraps to the DWELL value of the first element (Fig. 2-15,B). (default value is 100 ms).
<input type="button" value="1"/> <input type="button" value="5"/> <input type="button" value="1x ENTER"/>	Enter DWELL 15 s. The menu cursor automatically wraps to the MEMORY value of the second element.
<input type="button" value="1"/> <input type="button" value="1x ENTER"/>	Enter MEMORY 1. The menu cursor automatically wraps to the DWELL value of the second element. (default value is 100 ms).
<input type="button" value="RETURN"/>	Reset the menu cursor to the index.
<input type="button" value="RETURN"/>	Reset the menu cursor to the FUNCTION menu item of the EDIT page of menu MEM SEQ (c.f. Fig. 2-15,C).
<input type="button" value="RETURN"/>	Reset the menu cursor to the FUNCTION menu item of the OPERATION page of menu MEM SEQ.

Note: *With the return to the OPERATION page the operation of the list editor is finished.*

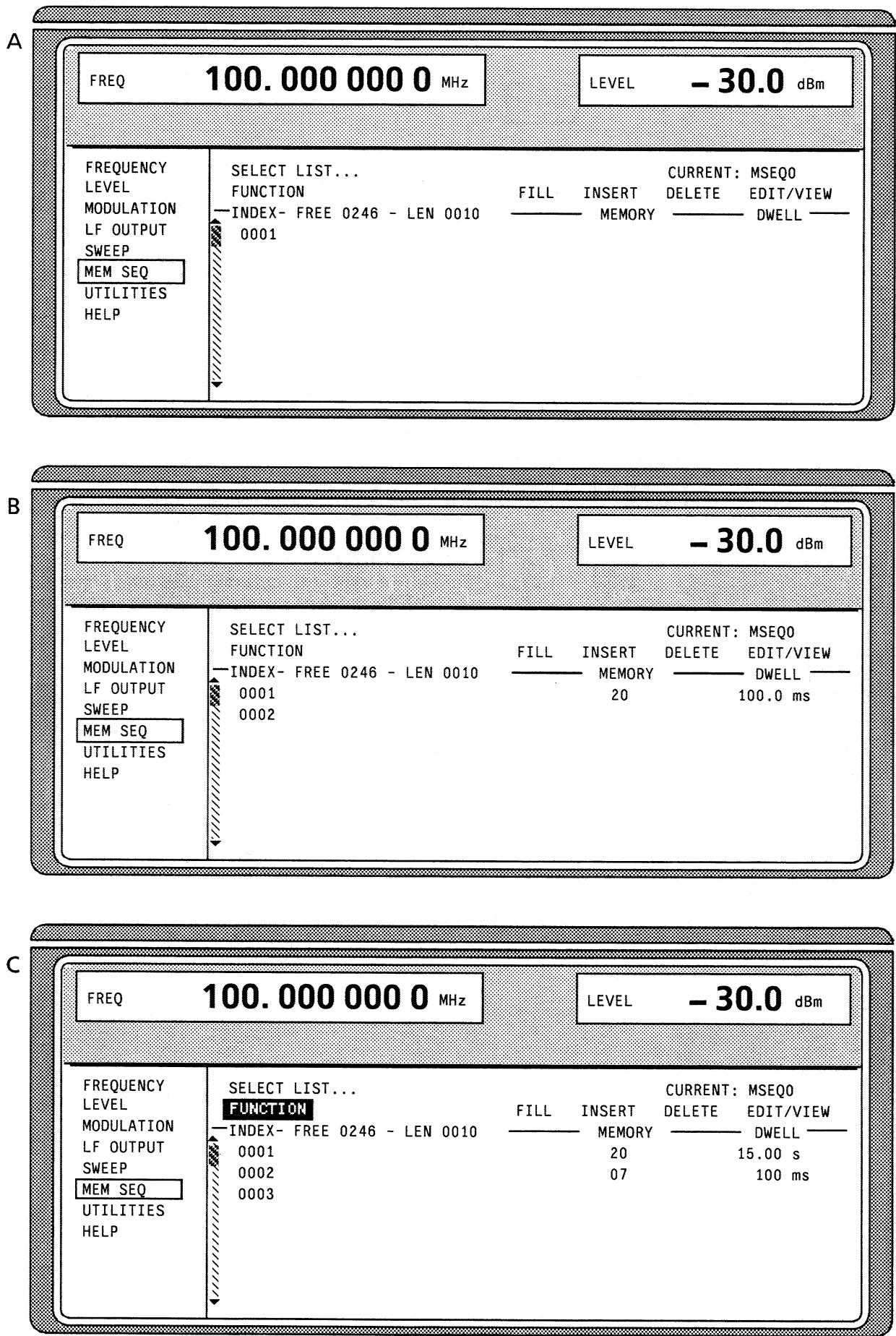

Fig. 2-15, A to C Pattern setting – Edition of a list

2.2.5 Save/Recall - Storing/Calling of Instrument Settings

50 complete instrument settings can be stored in memory locations 1 to 50.

Operating steps		Explanations
SAVE	1 2	1x ENTER
RCL	1 2	1x ENTER

Store current instrument setting in memory location 12.

Call instrument setting of memory location 12.

The digital display during a save or recall entry is faded in a window.

Memory location 0 has a special function. Here the instrument setting which was current prior to the last memory recall and prior to a preset setting is automatically stored. This permits the resetting of instrument settings which have inadvertently been deleted using Recall 0.

If an instrument setting is stored in which a sweep was switched on, the sweep is started using the recall.

Store IEC-bus command: "***SAV 12**"

Call IEC-bus command: "***RCL 12**"

Notes: *The contents of lists, as they are used for memory sequence or for user correction (UCOR), is not saved in the SAVE memory. It is stored under the respective list name and can be called. If instrument settings are called which go back to list data such as level setting using UCOR, the current list contents is used. If this has been altered, it is not identical to the list contents at the point of storing any more.*

Memory Sequence is dealt with in Section 2.9.

2.3 Menu Summary

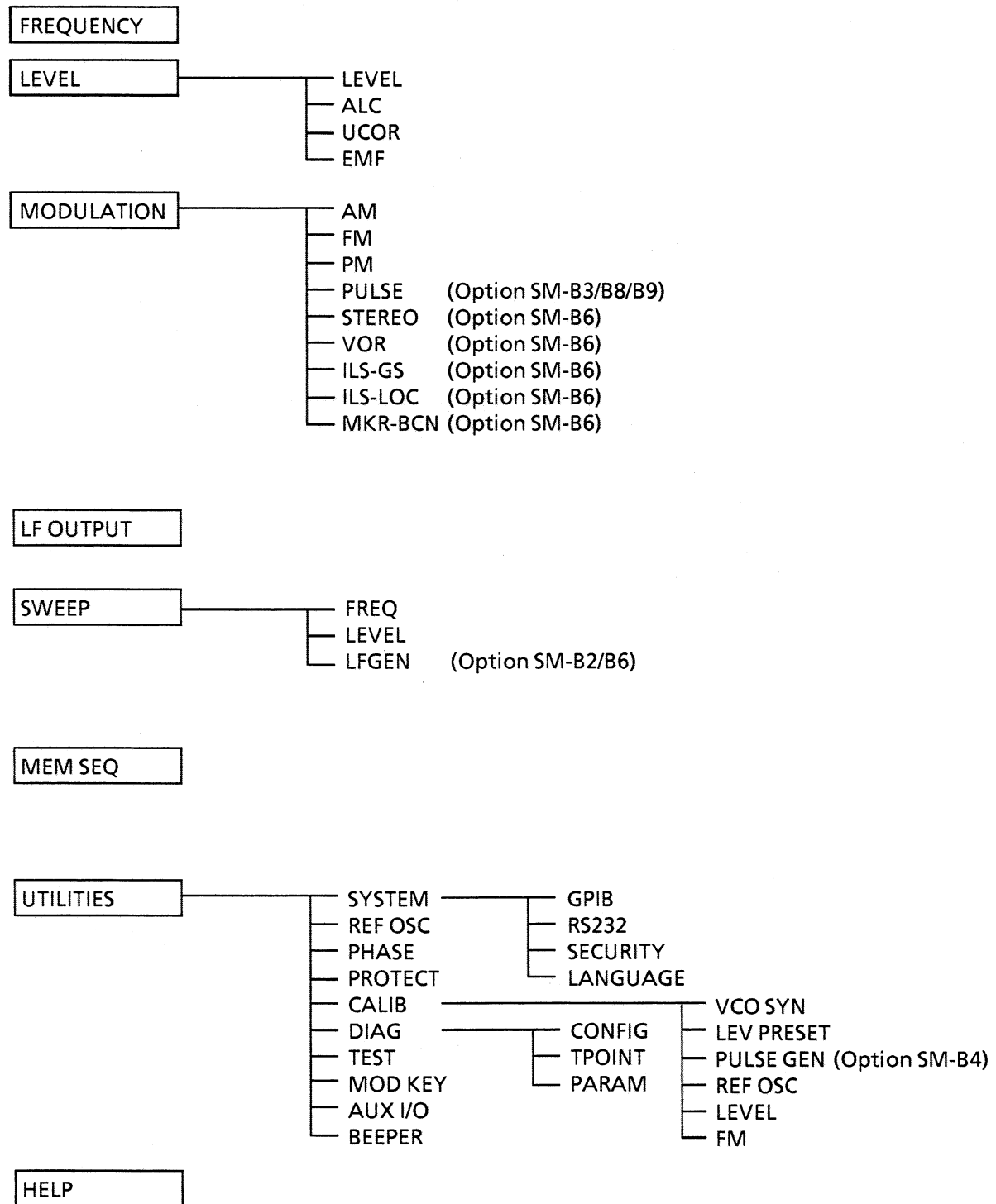

2.4 RF Frequency

The frequency of the RF output signal can be set directly using the [FREQ] key (cf. Section 2.2.2.5) or by accessing menu FREQUENCY.

In the header field of the display, the frequency of the RF output signal is indicated under FREQ.

In the case of frequency settings opened by means of the [FREQ] key, the value entered directly is the frequency of the RF output signal.

The input value of frequency settings effected in the FREQUENCY menu considers the offset in calculation (cf. Section 2.4.1). This offers the possibility of entering the desired output frequency of possibly series-connected instruments such as mixers in the menu.

Note: Further settings:

Frequency sweep	Menu SWEEP
LF frequency	Menu MODULATION
	Menu LF OUTPUT
int./ext. reference frequency	Menu UTILITIES-REF OSC
Phase of the output signal	Menu UTILITIES-PHASE

Menu selection: FREQUENCY

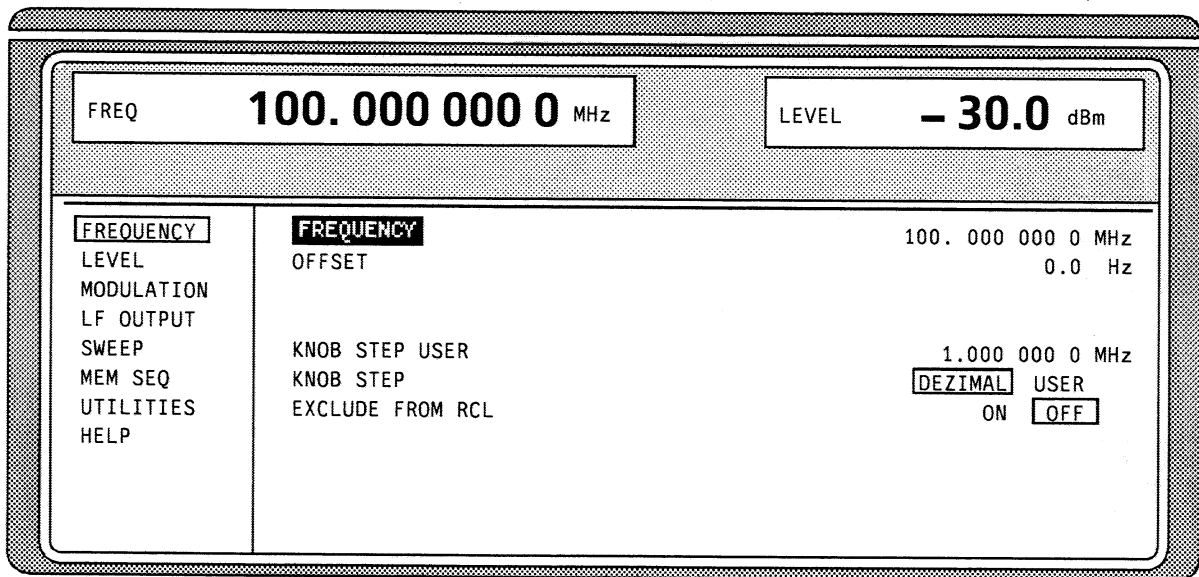

Fig. 2-16 Menu FREQUENCY (preset setting)

FREQUENCY Input value of the RF frequency considering the OFFSET input value. The frequency of the RF output signal is determined by input values FREQUENCY and OFFSET (cf. Section 2.4.1 Frequency Offset).
IEC-bus short command :FREQ 100E6

OFFSET Input value of a frequency offset, e.g., of a series-connected mixer (cf. Section 2.4.1, Frequency Offset).
IEC-bus short command :FREQ:OFFS 0

KNOB STEP USER Input value of the step width for frequency variation using the shaft encoder. The RF frequency is varied in the step width entered if KNOB STEP is set to USER.
IEC-bus short command :FREQ:STEP 1MHz

KNOB STEP **DECIMAL:** Variation step width corresponding to the position of the digit cursor.
USER: "User Defined", variation step width as entered under KNOB STEP USER.

EXCLUDE FROM RCL **OFF** The saved frequency is loaded when instrument settings are loaded with the [RECALL] key or with a memory sequence.
IEC-bus short command :FREQ:RCL INCL
ON The RF frequency is not loaded when instrument settings are loaded, the current settings are maintained.
IEC-bus short command :FREQ:RCL EXCL

2.4.1 Frequency Offset

The SMT offers the possibility of entering an offset (OFFSET) of possibly series-connected instruments in the FREQUENCY menu. The indication/input value under FREQUENCY considers this input and represents the frequency value of the RF signal at the output of these instruments (cf. Fig. 2-17).

Input values FREQUENCY and OFFSET in the FREQUENCY menu have the following connection with the frequency of the RF output signal:

$\text{FREQUENCY} - \text{OFFSET} = \text{output frequency}$

An offset input does not cause a variation of the RF output frequency, but only a variation of indication value FREQUENCY in the FREQUENCY menu.

The RF output frequency of the SMT is indicated in the header field of the display. It can be entered directly, i.e. without considering the offset using the [FREQ] key.

The offset setting also remains effective with the frequency sweep.

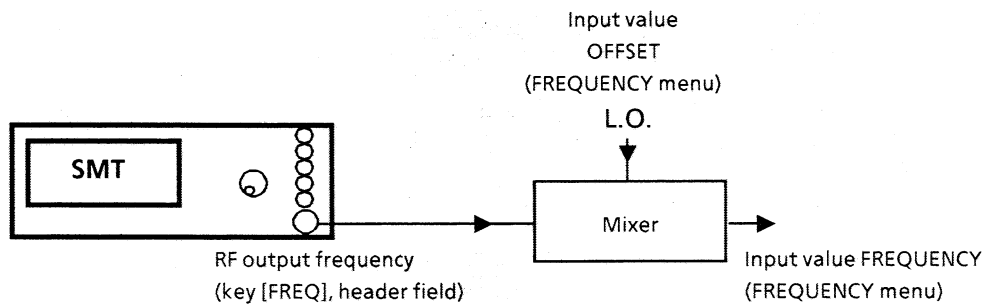

Fig. 2-17 Example of a circuit with frequency offset

2.5 RF Level

The RF output level can be set directly using the [LEVEL] key (cf. Section 2.2.2.5) or by accessing the LEVEL menu.

In the header field of the display, the set RF output level is indicated under LEVEL.

The input value of level settings opened using the [LEVEL] key directly corresponds to the RF output level.

The input value of the level settings effected in the LEVEL-LEVEL menu mathematically considers the offset of an attenuation/amplification element which is possibly series-connected (cf. Section 2.5.1). This offers the possibility of entering the desired level at the output of series-connected instruments, the SMT then alters the RF output level correspondingly. The offset can also be entered in the LEVEL-LEVEL menu.

dBm, dB μ V, mV and μ V can be used as level units. The 4 unit keys are directly labelled with these units. In order to change to another level unit, simply press the desired unit key.

- Notes:**
- The message *UNLEVELED* is displayed in the status line if the level set in the overrange is not reached.
 - Further settings: *Level sweep* menu *SWEEP*

Menu selection: LEVEL - LEVEL

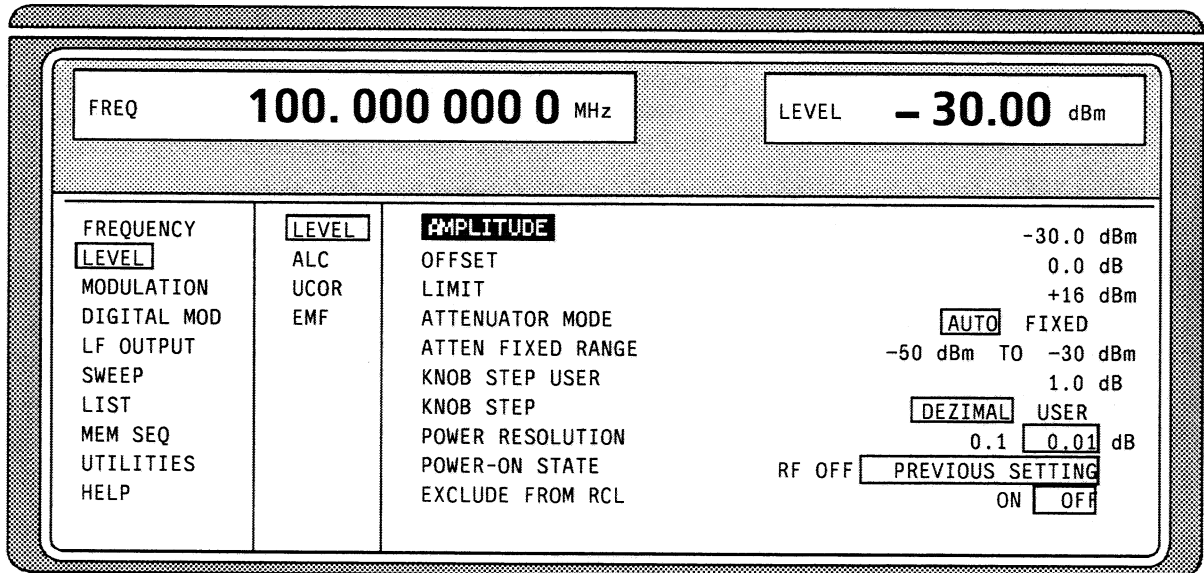

Fig. 2-18 Menu LEVEL (preset setting), POWER RESOLUTION is set to 0.01 dB

- AMPLITUDE** Input value of the RF level considering the OFFSET input value. The level of the RF output signal is determined by input values AMPLITUDE and OFFSET (cf. Section 2.5.2, Level Offset).
IEC-bus short command :*POW -30*
- OFFSET** Input value of the level offset of the RF output level compared to the input value of the RF level indicated in the LEVEL menu. Input in dB (cf. Section 2.5.1, Level Offset).
IEC-bus short command :*POW:OFFS 0*
- LIMIT** Input value of level limitation. This value indicates the upper limit of the level at the RF output connector. If a level above this limit is attempted to be set, a warning is displayed in the status line.
IEC-bus short command :*POW:LIM 16 dBm*
- ATTENUATOR MODE** AUTO Normal operation. The attenuator switching mechanically switches in steps of 5 dB, the switching points being fixed.
IEC-bus short command :*OUTP:AMOD AUTO*
- FIXED Level settings are effected without switching the attenuator (cf. Section 2.5.2, Interrupt-free Level Setting).
IEC-bus short command :*OUTP:AMOD FIX*
- ATTEN FIXED RANGE** Indication of the level range in which the level is set without interruption in the "ATTENUATOR MODE FIXED" operating mode.
- KNOB STEP USER** Input value of the step width for level variation using the rotary knob. The RF level is varied in the step width entered if KNOB STEP is set to USER.
IEC-bus short command :*POW:STEP 1*
- KNOB STEP** DECIMAL Variation step width according to the position of the digit cursor.
USER User Defined, variation step width as entered under KNOB STEP USER.
- POWER RESOLUTION** Selection of resolution of LEVEL display. For level range -99.9 dBm to +16 dBm the resolution for the level display can be set to 0.1 dB or 0.01 dB.
- POWER-ON STATE** Selection of the state the RF output is to assume after power-on of the unit.
RF OFF Output is switched off
PREVIOUS SETTING Same state as before switch-off
IEC-bus short command :*OUTP:PON UNCH*

EXCLUDE FROM RCL OFF The saved RF level is loaded when instrument settings are loaded with the [RECALL] key or with a memory sequence.
 ON The RF level is not loaded when instrument settings are loaded, the current settings are maintained.
 IEC-bus short command :*POW:RCL EXCL*

2.5.1 Level Offset

The SMT offers the possibility of entering the offset (OFFSET) of a possibly series-connected attenuator/amplification element in the LEVEL-LEVEL menu. The indication/input value under AMPLITUDE considers this input (see below) and represents the level value of the signal at the output of the series-connected instrument (cf. Fig. 2-19).

Input values LEVEL and OFFSET in the LEVEL menu have the following connection with the RF output level:

$$\text{LEVEL} - \text{OFFSET} = \text{output level}$$

An offset input does not effect an alteration of the RF output level, but only an alteration of the LEVEL indication value in the LEVEL menu. The offset is to be entered in dB.

The RF output level of the SMT is indicated in the header fields of the display. It can be entered directly, i.e. without considering an offset, using the [LEVEL] key.

The offset setting also remains effective in the ATTENUATOR MODE FIXED operating mode and with level sweep.

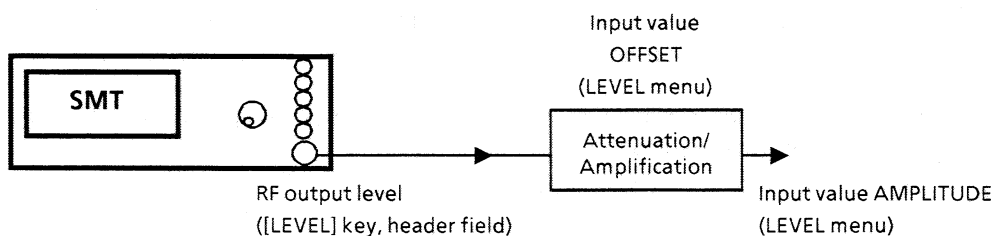

Fig. 2-19 Example of a circuit with level offset

2.5.2 Interrupt-free Level Setting

In the ATTENUATOR MODE FIXED operating mode, level settings are carried out without interruption. An electronic attenuation setting is used instead of the interrupting attenuator. The 20-dB range of the level which can be set interrupt-free extends from the level set on switching on the ATTENUATOR FIXED MODE until 20 dB below. Within this 20-dB range, the level can be set via the keyboard, via the rotary knob or via the IEC bus.

2.5.3 Switching On/Off Internal Level Control

Menu LEVEL-ALC offers access to settings for level control.

Level control can be deactivated and various bandwidths of the level control can be switched on.

Switching off level control (ALC STATE OFF) switches over the internal level control into a sample-and-hold operation. In this operating mode, level control is automatically switched on for a short period of time after every level and frequency setting, and then the level control is held at the value achieved. Switching off the level control is used with multi-transmitter measurements to achieve a larger intermodulation ratio.

Bandwidth setting influences the AM noise of the output signal. The bandwidth of the level control has the same effect as a filter of the same bandwidth.

Menu selection: LEVEL - ALC

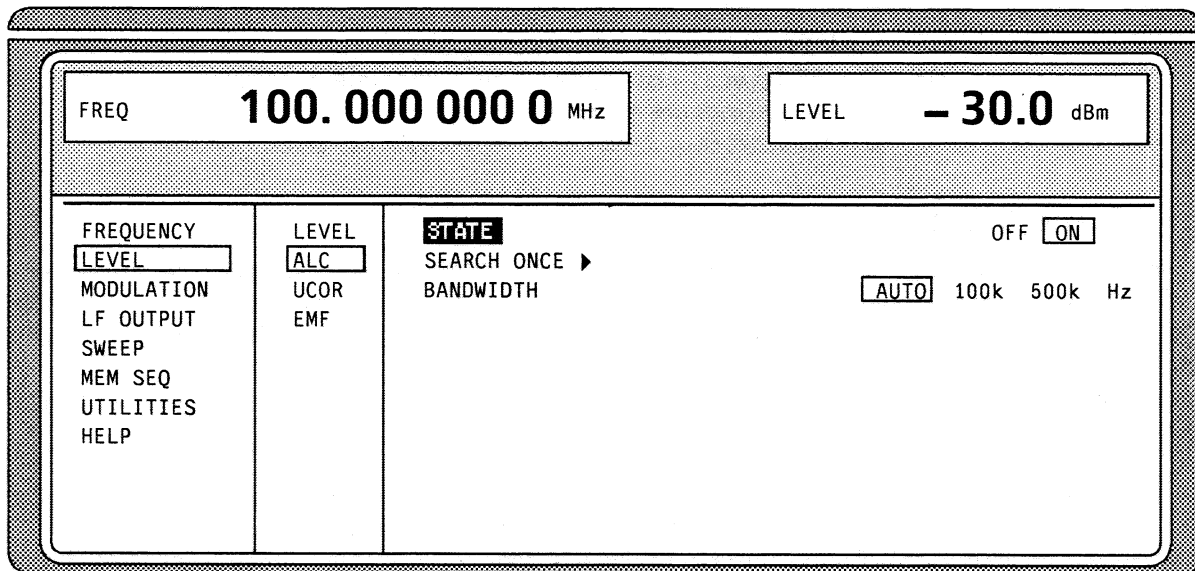

Fig. 2-20 Menu LEVEL-ALC (preset setting)

STATE

ON Normal state. Internal level control is permanently switched on.
IEC-bus short command :*POW:ALC ON*

OFF Internal level control is deactivated. In this state no AM is possible.
IEC-bus short command :*POW:ALC OFF*

SEARCH ONCE ▶ Manual short-time switching on of the level control for level calibration in the ALC STATE OFF operating mode.
IEC-bus short command :*POW:ALC ON; ALC OFF*

2.5.4 Internal Level Control – Bandwidth Selection

BANDWIDTH Selection of the bandwidth of the level control.

AUTO The bandwidth is automatically adapted to the operating conditions.
IEC-bus short command :*POW:ALC:BAND:AUTO ON*

100 kHz Bandwidth narrow. This setting improves AM noise with carrier offset > 100 kHz. However, the AM bandwidth is restricted.
IEC-bus short command :*POW:ALC:BAND 100kHz;BAND:AUTO OFF*

500 kHz Full bandwidth
IEC-bus short command :*POW:ALC:BAND 500kHz;BAND:AUTO OFF*

2.5.5 User Correction (UCOR)

Function "User Correction" can be used to create and activate lists in which arbitrary RF frequencies are assigned level correction values. Up to 10 lists with a total of 160 correction values can be compiled. For frequencies which are not included in the list the level correction is determined by means of interpolation of the nearest correction values.

When user correction is switched on, the LEVEL indication is completed by the indication UCOR (User Correction) in the header field of the display. The RF output level is the sum of both values.

$$\text{LEVEL} + \text{UCOR} = \text{output level}$$

If the offset setting is used at the same time, the LEVEL indication value is the difference of the input values AMPLITUDE and OFFSET of the menu LEVEL.

$$\text{AMPLITUDE} - \text{OFFSET} = \text{LEVEL}$$

The user correction is effective in all operating modes if switched on.

Menu selection: LEVEL - UCOR

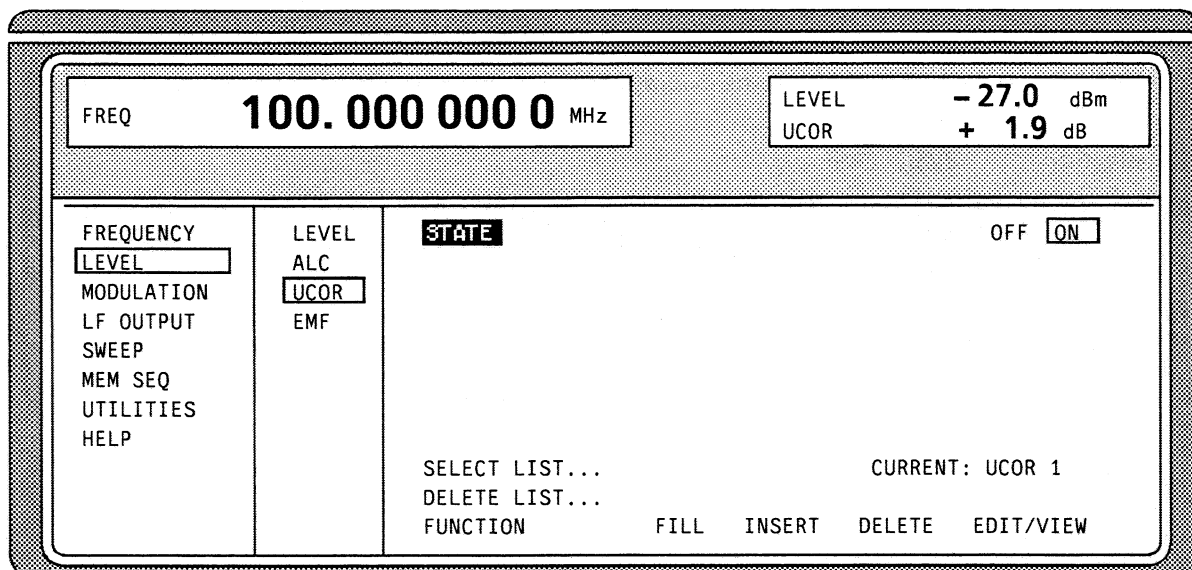

Fig. 2-21 Menu LEVEL-UCOR – OPERATION page

- STATE** Switching on/off user correction.
IEC-bus short command :CORR ON
- SELECT LIST...** Selection of a list or generation of a new list (cf. Section 2.2.4, List Editor).
IEC-bus short command :CORR:CSET "UCOR1"
- DELETE LIST...** Deletion of a list (cf. Section 2.2.4, List Editor).
IEC-bus short command :CORR:CSET:DEL "UCOR1"
- FUNCTION** Selection of the editing mode to process the selected list (cf. Section 2.2.4, List Editor).
IEC-bus short command :CORR:CSET:DATA:FREQ 100MHz, 102MHz,...
 :CORR:CSET:DATA:POW 1dB, 0.8dB,...

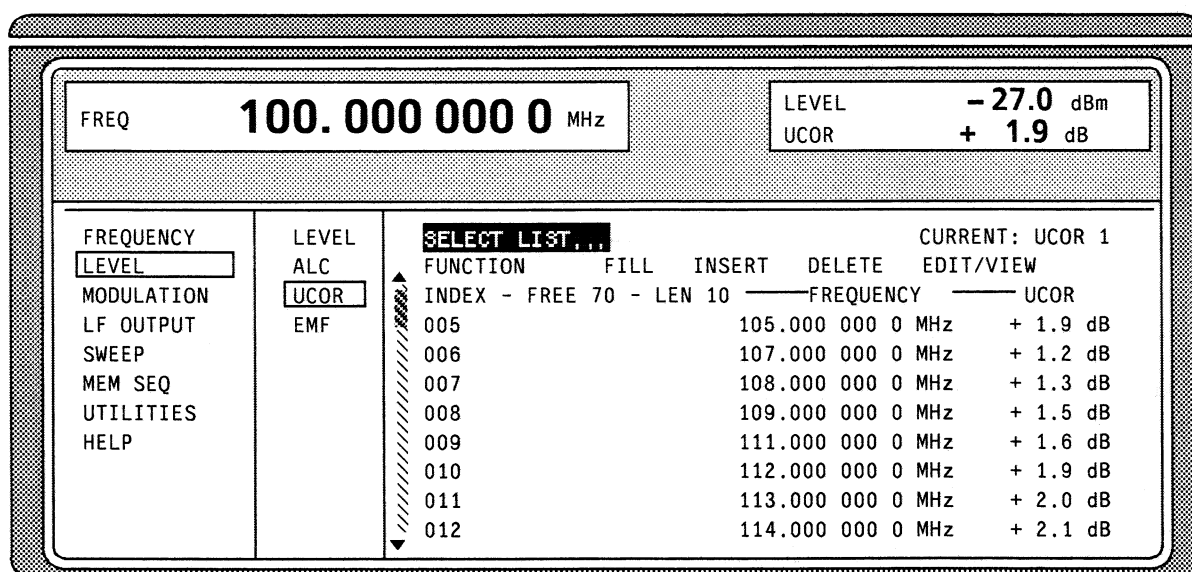

Fig. 2-22 Menu LEVEL-UCOR – EDIT page

2.5.6 EMF

The signal level can also be set and indicated as the voltage of EMF (open-circuit voltage).

EMF is displayed in the header field of the display after the unit of the level indication if one of units dB μ V, mV or μ V is selected.

Menu selection: LEVEL - EMF

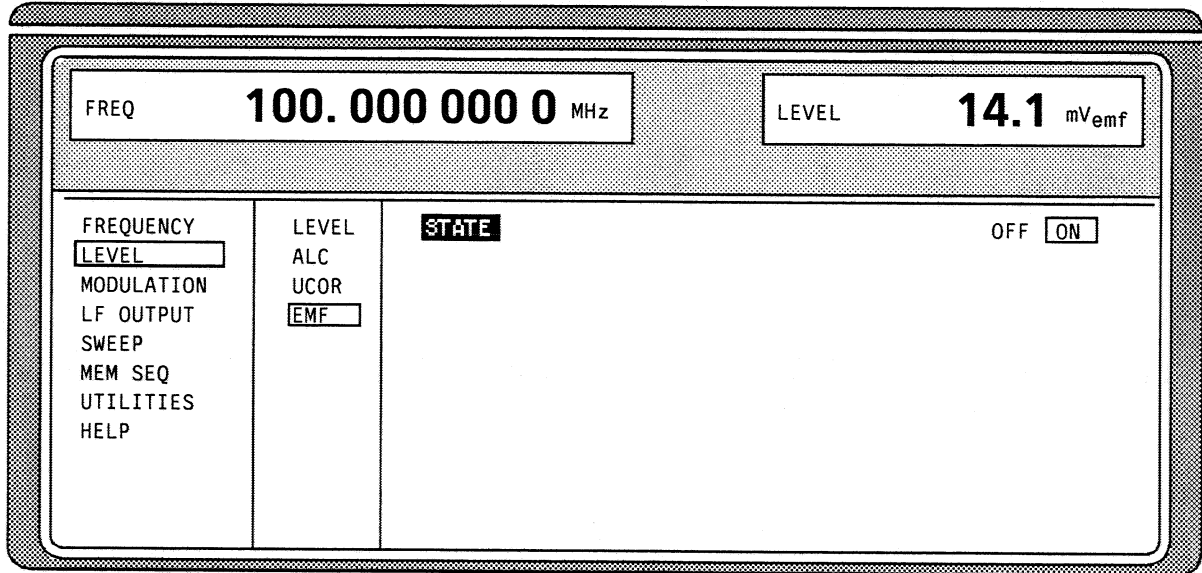

Fig. 2-23 Menu LEVEL-EMF (preset setting)

STATE	ON	Voltage value of the level is the voltage of EMF.
	OFF	Voltage value of the level is voltage at 50 Ω .

2.5.7 [RF ON / OFF] Key

The RF output signal is switched on and off again using the [RF ON / OFF] key. This does not influence the current menu. When the output signal is switched off, the message "RF OFF" is displayed in the LEVEL indication of the header field. If RF OFF is displayed, the 50- Ω source resistance is maintained.

IEC-bus short command :*OUTP OFF*

2.5.8 Reset Overload Protection (SMT02/03 only)

SMT02 and SMT03 are protected against overload by an external signal which is fed into the RF output. If an external signal is too high, the overload protection responds. This state is indicated by means of the message "RF OFF" in the LEVEL indication in the header field and the message "OVERLOAD" in the status line. SMT06 is not protected against overload, the IEC/IEEE-Bus command being ignored

- ▶ Reset the overload protection by pressing the [RF ON / OFF] key.

IEC-bus short command :*OUTP:PROT:CLE*

The SMT06 doesn't have an overload protection.

2.6 Modulation

The SMT offers the following modulations:

- Amplitude modulation (AM)
- Frequency modulation (FM)
- Phase modulation (PM)
- Pulse modulation (PULSE) *
- FM-stereo modulation (STEREO) *
- VOR/ILS modulation (VOR, ILS-GS, ILS-LOC, MKR BCN) * * Only with option

Internal or external modulation sources can be used for all modulations.

2.6.1 Modulation Sources

Internal Modulation Sources

Internal modulation generators LF GEN1 and LF GEN2 are available for AM, FM and PM depending on the equipment. For a more detailed description, cf. Section 2.6.2.1, LF Generator.

For internal pulse modulation, the instrument can be equipped with a pulse generator (option SM-B4). For a more detailed description, cf. Section 2.6.5.1, Pulse Generator.

External Modulation Sources

The appropriate input sockets to the different modulations in the case of external supply can be taken from table 2-1. External AM, FM and PM can be AC or DC-coupled.

Table 2-1 Input sockets for the different types of modulation

Modulation	Inputs		
	EXT1	EXT2	PULSE
AM	X		
FM1	X	X	
FM2		X	
PM1	X	X	
PM2		X	
PULSE			X

The external modulation signal must show a voltage of $V_s = 1 \text{ V}$ ($V_{\text{eff}} = 0.707 \text{ V}$) in order to maintain the modulation depth or deviation indicated. Deviations of more than $\pm 3 \%$ are signalled in the status line by means of the following messages (cf. table 2-2). Monitoring is only active if the inputs are AC-coupled.

Table 2-2 Status messages in the case of a deviation from the rated value at the external modulation input

Message	Deviation
EXT1-HIGH	Voltage at EXT1 too high
EXT1-LOW	Voltage at EXT1 too low
EXT2-HIGH	Voltage at EXT2 too high
EXT2-LOW	Voltage at EXT2 too low
EXT-HI/HI	Voltage at EXT1 and EXT2 too high
EXT-LO/LO	Voltage at EXT1 and EXT2 too low
EXT-HI/LO	Voltage at EXT1 too high and EXT2 too low
EXT-LO/HI	Voltage at EXT1 too low and EXT2 too high

2.6.1.1 Simultaneous Modulation

Basically, every combination of AM, FM and pulse modulation is possible. Instead of FM, phase modulation (PM) can be switched on as well. There are only restrictions for modulations of the same kind and for the multiple use of the 2nd LF generator (cf. table 2-3).

Two-tone AM is possible by simultaneously switching on the external and internal source.

Two-tone FM or two-tone PM is possible by simultaneously switching on FM1 and FM2 or PM1 and PM2. For FM1 and FM2 (PM1 and PM2) separate deviations can be set and separate sources switched on.

Note: *With two-tone modulation please observe that the set deviation or modulation depth is valid for one signal and the sum deviation or sum modulation depth is determined by adding both signals. This results in overmodulation if the maximal value for deviation or modulation depth is exceeded.
To guarantee a deviation error of max. 3%, the ratio of the two deviations has to be < 100 with dual sound FM/PM.*

2.6.1.2 Alternate Switching Off of Modulations

Due to the multiple use of some functional modules in the instrument some modulations cannot be set at the same time (cf. table 2-3). In the case of manual control, incompatible modulations deactivate one another, a short-time warning is displayed in the status line.

Note: *The IEC-bus control according to SCPI forbids the mutual influence of types of modulation on one another. In the case of remote control, an error message is outputted when the attempt is made to switch on incompatible types of modulation (cf. annex B).*

Table 2-3 Modulations which cannot be operated simultaneously.

	AM INT1	AM INT2	AM EXT1	FM1 INT1	FM1 EXT1,2	FM2 INT2	FM2 EXT1,2	PM1 INT1	PM1 EXT1,2	PM2 INT2	PM2 EXT1,2	Stereo	VOR	ILS	MCR-BCN
AM INT1													×	×	×
AM INT2												×	×	×	×
AM EXT1													☒	☒	×
FM1 INT1					□			×	×	×	×				
FM1 EXT1,2				□				×	×	×	×				
FM2 INT2							□	×	×	×	×	×	×	×	×
FM2 EXT1,2						□		×	×	×	×	×			
PM1 INT1				×	×	×	×		□			×			
PM1 EXT1,2				×	×	×	×	□				×			
PM2 INT2				×	×	×	×				□	×	×	×	×
PM2 EXT1,2				×	×	×	×			□		×			
Stereo		×				×	×	×	×	×	×		×	×	×
VOR	×	×	☒			×				×		×		×	×
ILS	×	×	☒			×				×		×	×		×
MCR-BCN	×	×	×			×				×		×	×	×	

- × Mutual switching off in the case of manual control
- ☒ In the VOR- (ILS..) menu AM EXT can be added as an own parameter
- Switching off by means of 1-out-of-n selection

2.6.1.3 [MOD ON/OFF] Key

The modulations can directly be switched on/off using the key or by accessing the MODULATION menu. When switching on using the [MOD ON/OFF] key, the modulation sources which are set in the modulation menus are used.

The [MOD ON/OFF] key can either be effective for all modulations or for a selected modulation. The selection for which modulation the [MOD ON/OFF] key is effective is made in the UTILITIES-MOD KEY menu. (cf. Section "Assigning Modulation to [MOD ON/OFF] Key").

When selecting a certain type of modulation, each pressing the [MOD ON/OFF] key switches on or off the modulation selected.

In the case of selection "all modulations", the [MOD ON/OFF] key has the following effect:

- At least one modulation is active:
Pressing the [MOD ON/OFF] key switches off all active modulations. Which modulations were active is stored.
- No modulation is active:
Pressing the [MOD ON/OFF] key switches on the modulations which were last switched off using the [MOD ON/OFF] key.

2.6.1.4 LF-Generator

The SMT is equipped with a fixed-frequency generator as internal modulation source as a standard. The generator supplies sinusoidal signals of the frequencies of 0.4, 1, 3 and 15 kHz. In addition to the standard equipment, the SMT can be equipped with the following optional LF modulation sources:

- LF-generator, option SM-B2
- Multifunction generator, option SM-B6

It is possible to fit two optional modulation sources unless option SM-B3, pulse modulator, is fitted. If two options are fitted, the access to the internal standard generator is eliminated. The different possibilities of modulation generator fitting are visible from table 2-4:

Table 2-4 Modulation generators as component parts

LF-Generator 1	LF-Generator 2
Standard generator	—
Standard generator	Option SM-B2, LF-generator
Standard generator	Option SM-B6, multifunction generator
Option SM-B2, LF-generator	Option SM-B2, LF-generator
Option SM-B2, LF-generator	Option SM-B6, multifunction generator

The selection of the waveform and frequency of the internal modulation signals can be made in one of the modulation menus (AM, FM, PM) as well as in the LF-output menu.

- Notes:**
- *In conformance to the possibilities of the modulation generator options fitted, there are differences in the modulation menus for AM, FM and PM.*
 - *The settings LFGEN SHAPE NOI and LF sweep deactivate one another.*

2.6.2 Amplitude Modulation

Menu MODULATION-AM offers access to settings for amplitude modulation.

- Notes:**
- In the level range from 7 dBm to 13 dBm, the specified AM data are only guaranteed for a linearly decreasing modulation depth with a rising level. When a modulation depth is set that is too high, "WARNING" is displayed in the status line or the message "WARN -221 Settings conflict; AM forces level into overrange" is displayed after pressing the ERROR key.
 - Modulations AM, VOR, ILS and MKR BCN deactivate one another.
Settings AM SOURCE INT = LFGEN2 and STEREO deactivate one another as well.

Menu selection: MODULATION- AM

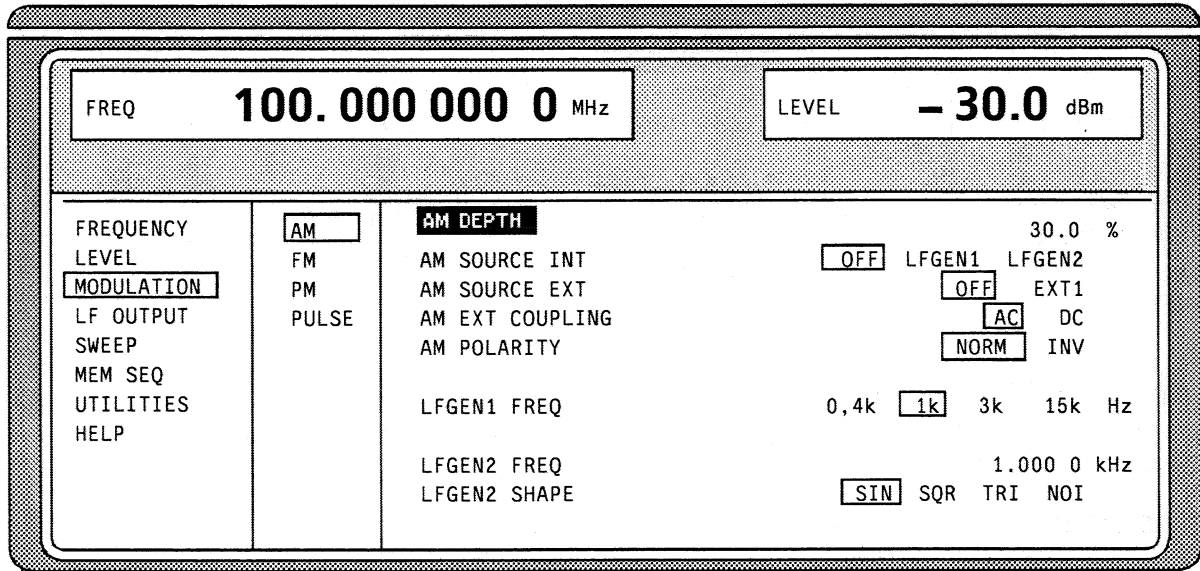

Fig. 2-24 Menu MODULATION-AM (preset setting), fitted with option SM-B2, LF-generator (LFGEN2)

- AM DEPTH** Input value of the modulation depth.
IEC-bus short command :AM 30PCT
- AM SOURCE INT** Selection of the internal source.
IEC-bus short command :AM:SOUR INT1; STAT ON
- AM SOURCE EXT** Selection of the external source.
IEC-bus short command :AM:SOUR EXT; STAT ON
- AM EXT COUPLING** Selection of the kind of coupling AC or DC with external supply.
IEC-bus short command :AM:EXT:COUP AC
- AM POLARITY** Selection of the polarity of amplitude modulation.
NORM A positive modulation voltage generates a higher output level.
INV The AM polarity is inverted.
IEC-bus short command :AM:POL NORM
- LFGEN1 FREQ** Selection of the frequency of the 1st LF generator.
IEC-bus short command :AM:INT1:FREQ 1kHz
- LFGEN2 FREQ** Input value of the frequency of the 2nd LF generator.
IEC-bus short command :AM:INT2:FREQ 1kHz
- LFGEN2 SHAPE** Selection of the waveform of the 2nd LF generator.
IEC-bus short command :SOUR2:FUNC SIN

2.6.3 Frequency Modulation

Menu MODULATION-FM offers access to settings for frequency modulation.

Note: *The following modulations cannot be set simultaneously and deactivate one another: FM and PM; FM2 and STEREO; FM2 SOURCE = LFGEN2 and VOR, ILS, MKR BCN*

Menu selection: MODULATION-FM

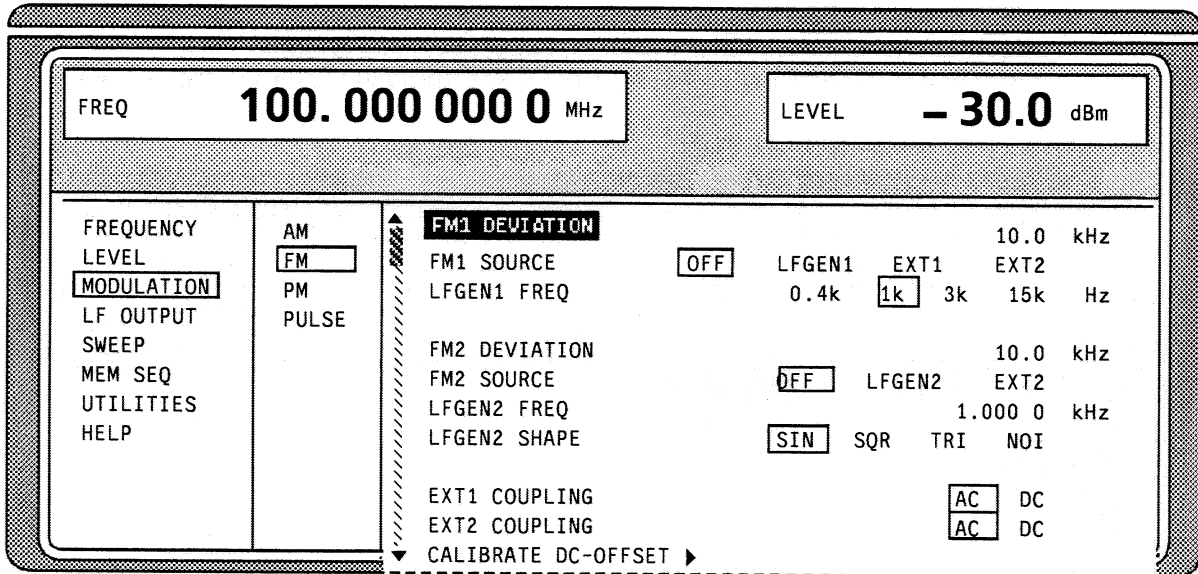

Fig. 2-25 Menu MODULATION-FM (preset setting), fitted with option SM-B2, LF-generator (LFGEN2).

- FM1 DEVIATION** Input value of the deviation for FM1.
IEC-bus short command :FM1 10kHz
- FM1 SOURCE** Switching on and off FM1 and selection of the modulation source.
IEC-bus short commands :FM1:SOUR INT; STAT ON
- LFGEN1 FREQ** Selection of the frequency of the 1st LF generator.
IEC-bus short command :FM1:INT:FREQ 1kHz
- FM2 DEVIATION** Input value of the deviation for FM2.
IEC-bus short command :FM2 10kHz
- FM2 SOURCE** Switching on and off FM2 and selection of the modulation source.
IEC-bus short command :FM2:STAT OFF
- LFGEN2 FREQ** Input value of the LFGEN2 frequency.
IEC-bus short command :FM2:INT:FREQ 1kHz
- LFGEN2 SHAPE** Selection of the waveform of the 2nd LF generator.
IEC-bus short command :SOUR2:FUNC SIN
- EXT1 COUPLING** Selection of the type of coupling AC or DC for the external input EXT1.
IEC-bus short command :FM1:EXT1:COUP AC
- EXT2 COUPLING** Selection of the type of coupling AC or DC for the external input EXT2.
IEC-bus short command :FM1:EXT2:COUP AC

CALIBRATE DC-OFFSET ▶ Triggers the calibration of the carrier mean frequency. DC offsets in the modulation path and of the source are compensated for.

Caution: *In the case of an AC-coupling of the modulator, CALIBRATE DC-OFFSET ▶ is not possible. The modulator is DC-coupled with settings EXT1 DC and EXT2 DC, also in combination with other inputs.*

IEC-bus short command :CAL:FM:OFFS?

2.6.3.1 FM Deviation Limits

The maximal deviation depends on the RF frequency set (cf. Fig. 2-26). It is possible to enter a deviation that is too high for a certain RF frequency or to vary the RF frequency to a range in which the deviation can no longer be set. In this case the maximally possible deviation is set and an error message is displayed.

In the RF range 93.75 MHz to 130 MHz a different synthesis range is selected depending on the deviation set. If the deviation is smaller than 80 kHz, the synthesizer is in the division range with optimal spectral purity. If the deviation set is larger than 80 kHz, the extended heterodyne band is automatically selected.

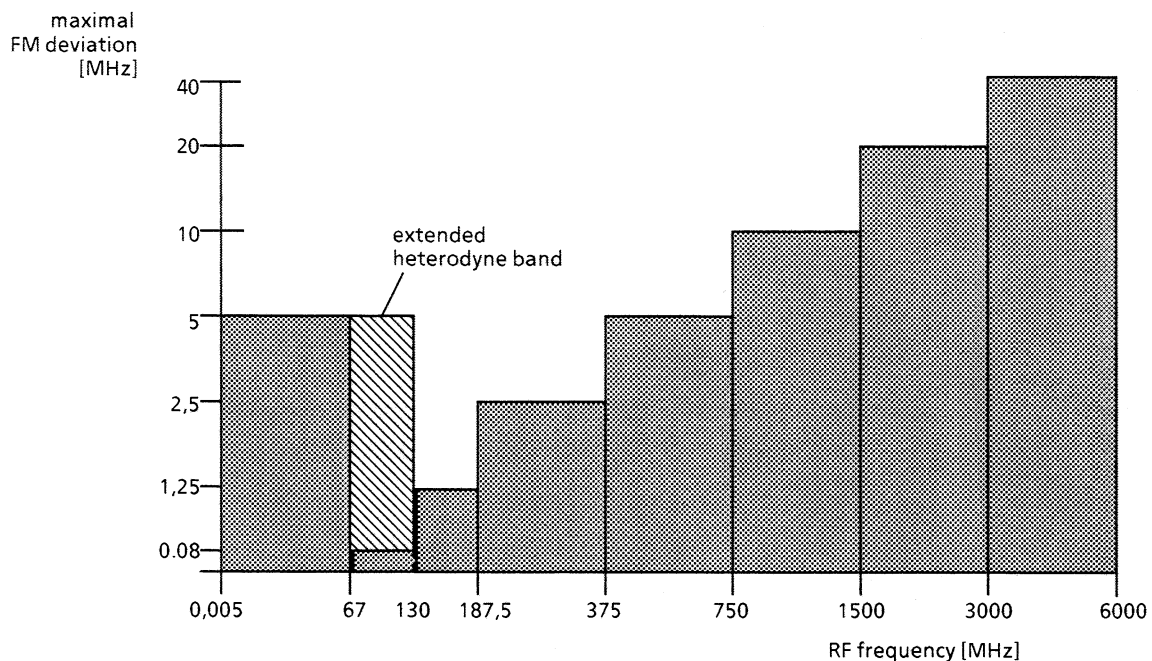

Fig. 2-26 Dependency of the FM maximal deviation on the RF frequency set

2.6.4 Phase Modulation

The PM menu offers access to settings for phase modulation.

Note: The following modulations cannot be set simultaneously and deactivate one another:

PM and FM

PM and STEREO

PM2 SOURCE = LFGEN2 and VOR, ILS, MKR BCN

Menu selection: MODULATION - PM

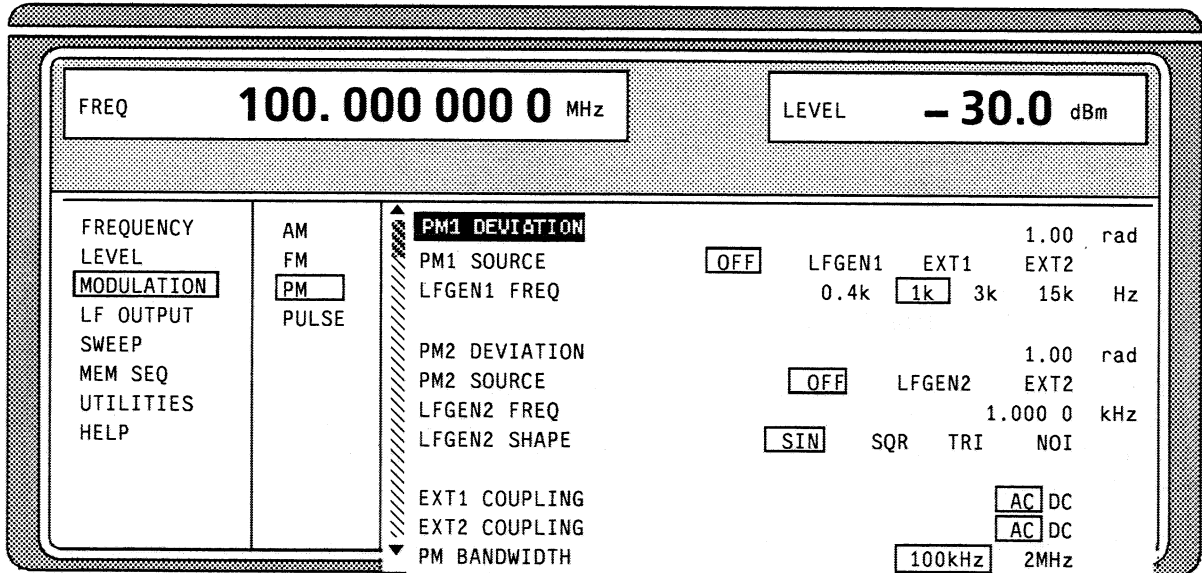

Fig. 2-27 Menu MODULATION-PM (preset setting), fitted with option SM-B2, LF generator (LFGEN2).

- PM1 DEVIATION** Input value of the deviation for PM1 (cf. Section 2.6.4.1, PM Deviation Limits).
IEC-bus short command :PM1 1RAD
- PM1 SOURCE** Switching on and off PM1 and selection of the modulation source.
IEC-bus short command :PM1:SOUR:INT;STAT ON
- LFGEN1 FREQ** Selection of the frequency of the 1st LF generator.
IEC-bus short command :PM1:INT:FREQ 1kHz
- PM2 DEVIATION** Input value of the deviation for PM2 (cf. Section 2.6.4.1, PM Deviation Limits).
IEC-bus short command :PM2 1RAD
- PM2 SOURCE** Switching on and off PM2 and selection of the modulation source.
IEC-bus short command :PM2:SOUR INT;STAT ON
- LFGEN2 FREQ** Input value of the LFGEN2 frequency.
IEC-bus short command :PM2:INT:FREQ 1kHz
- LFGEN2 SHAPE** Selection of the waveform of the 2nd LF generator.
IEC-bus short command :SOUR2:FUNC SIN
- EXT COUPLING** Selection of the type of coupling AC or DC for external input EXT1.
IEC-bus short command :PM:EXT1:COUP AC
- EXT2 COUPLING** Selection of the type of coupling AC or DC for external input EXT2.
IEC-bus short command :PM:EXT2:COUP AC
- PM BANDWIDTH** Selection of the modulation bandwidth.
IEC-bus short command :PM:BAND 100kHz

2.6.4.1 PM Deviation Limits

The maximal deviation depends on the RF frequency set and on the PM bandwidth (cf. Fig. 2-28). It is possible to enter a deviation that is too high for a certain RF frequency or to vary the RF frequency to a range in which the deviation can no longer be set. In this case the maximally possible deviation is set and an error message displayed.

In the RF range 67 MHz to 130 MHz a different synthesis range is selected depending on the deviation set. If the deviation is small, the synthesizer is in the division range with optimal spectral purity. If the deviation is large (shaded area), the extended heterodyne band is automatically selected.

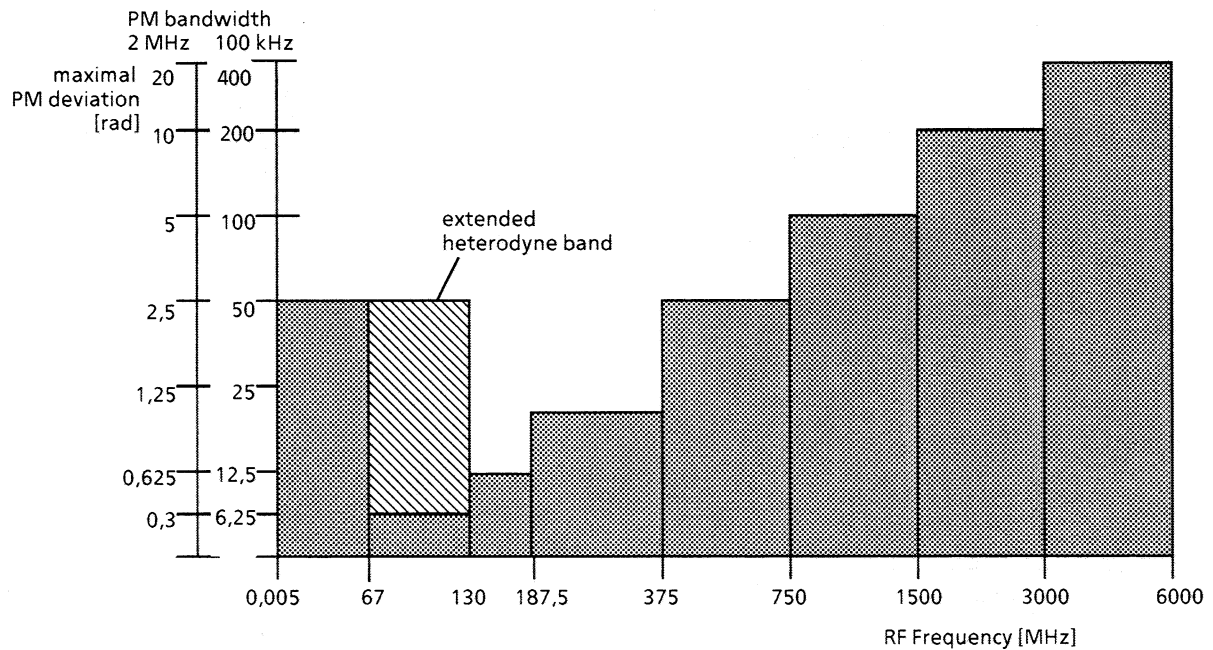

Fig. 2-28 Dependency of the PM maximal deviation on the RF frequency set

2.6.5 Pulse Modulation

The pulse modulator can be controlled by an external source as well as by the internal pulse generator. In the case of external control, the external source directly feeds the pulse modulator. The envelope of the RF is identical to the control signal. In the case of control by the internal pulse generator, the pulse form of the pulse generator determines the envelope of the RF. Pulse delay, pulse width and period can be set.

The polarity of the pulse modulation is selectable. With POLARITY = NORM, the RF level is on with HIGH level at modulation input PULSE. The input resistance is selectable between 50 Ω and 10 k Ω .

2.6.5.1 Pulse Generator

As an internal modulation source, the pulse generator offers the possibility to set single and double pulses with variable pulse delay, pulse width and period. The pulse generator can be triggered internally or by means of an external signal at the PULSE input. The internal triggering is derived from the reference frequency and hence very stable. In trigger mode EXT, the positive or the negative edge can be used to trigger the pulse generator.

The pulse generator can also be operated as an independent function without the pulse modulator being controlled if the pulse modulation source SOURCE is switched to OFF or EXT. The pulse can be tapped at the VIDEO output.

The PULSE input is at the front of the instrument. The SYNC and VIDEO output are at the rear of the instrument.

Signal examples:

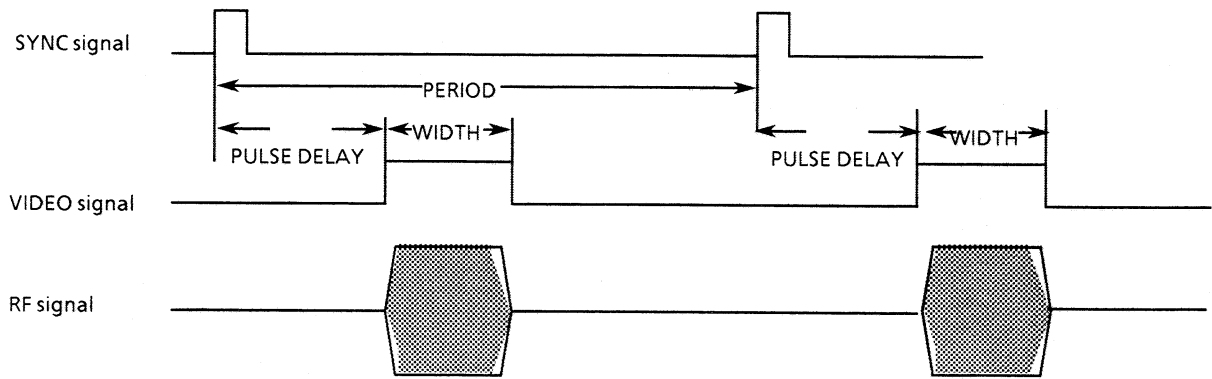

Fig. 2-29 Signal example 1: single pulse, TRIGGER MODE = AUTO

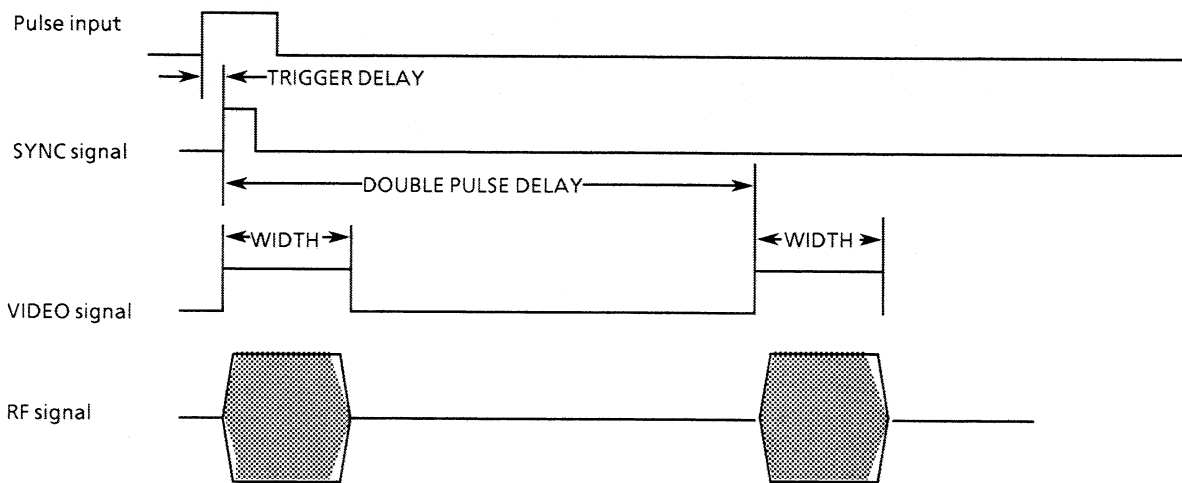

Fig. 2-30 Signal example 2: double pulse, TRIGGER MODE = EXT, SLOPE = POS

The PULSE menu offers access to settings for pulse modulation and to the pulse generator. If only option SM-B3, pulse modulator, is fitted, only the first 3 lines are displayed in the setting menu.

Menu selection: MODULATION - PULSE

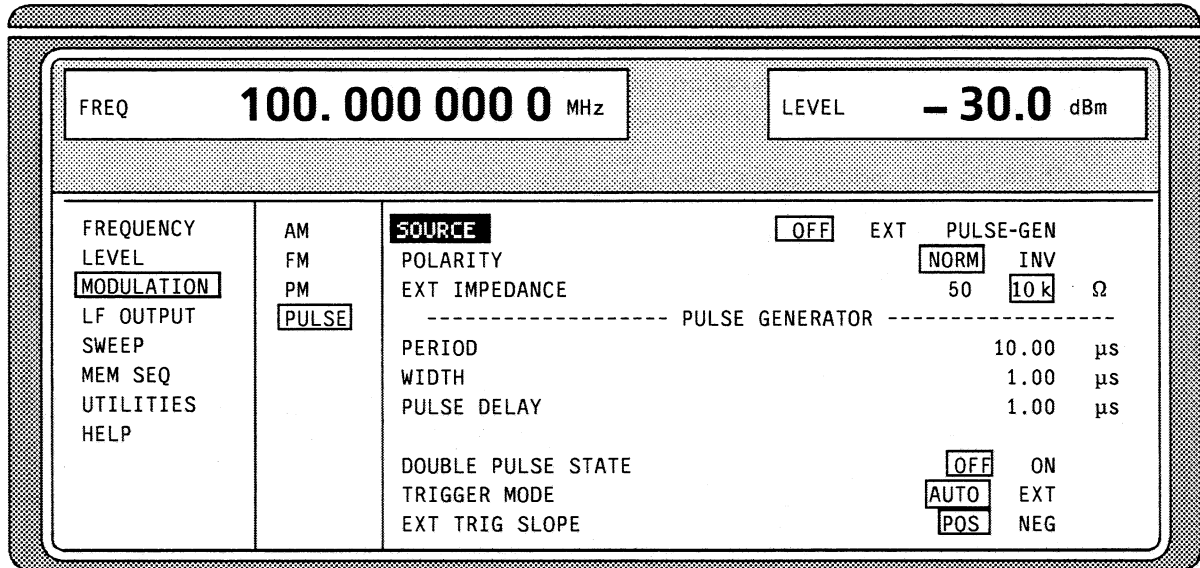

Fig. 2-31 Menu MODULATION-PULSE (preset setting), fitted with option SM-B3, pulse modulator, and SM-B4, pulse generator.

- SOURCE** Selection of the modulation source.
IEC-bus short command :*PULM:SOUR INT; STAT ON*
- POLARITY** Selection of the polarity of the modulation signal.
NORM The RF signal is on during high level.
INV The RF signal is suppressed during high level.
IEC-bus short command :*PULM:POL NORM*
- EXT IMPEDANCE** Selection of the input resistance 50 Ω or 10 kΩ.
IEC-bus short command :*PULM:EXT:IMP 50*
- PERIOD** Input value of the period.
IEC-bus short command :*PULS:PER 10us*
- WIDTH** Input value of the pulse width.
IEC-bus short command :*PULS:WIDT 1us*
- PULSE DELAY** Input value of the single-pulse delay. Is only displayed if DOUBLE PULSE STATE is set to be OFF.
IEC-bus short command :*PULS:DEL 1 us*
- DOUBLE PULSE DELAY** Input value of the double-pulse delay.
IEC-bus short command :*PULS:DOUB:DEL 1us*
- DOUBLE PULSE STATE** Switching on/off the double pulses.
ON Double pulse is switched on
OFF Single pulse
IEC-bus short command :*PULS:DOUB ON*
- TRIGGER MODE** Selection of the trigger mode.
AUTO Period as entered under PERIOD.
EXT Period is determined by the external signal at the PULSE input.
IEC-bus short command :*TRIG:PULS:SOUR AUTO*
- EXT TRIG SLOPE** Selection of the active edge of the external trigger signal.
POS Pulse generator triggers on positive edge of the external signal.
NEG Pulse generator triggers on negative edge of the external signal.
IEC-bus short command :*TRIG:PULS:SLOP POS*

2.6.6 STEREO Modulation

By means of option SM-B6, multifunction generator, STEREO multiplex signals conforming to standards can be generated according to the pilot-tone method.

Note: The following modulations cannot be set simultaneously and deactivate one another:

STEREO and FM

STEREO and PM

STEREO and AM if SOURCE AM = LFGEN2

Menu selection: MODULATION:STEREO

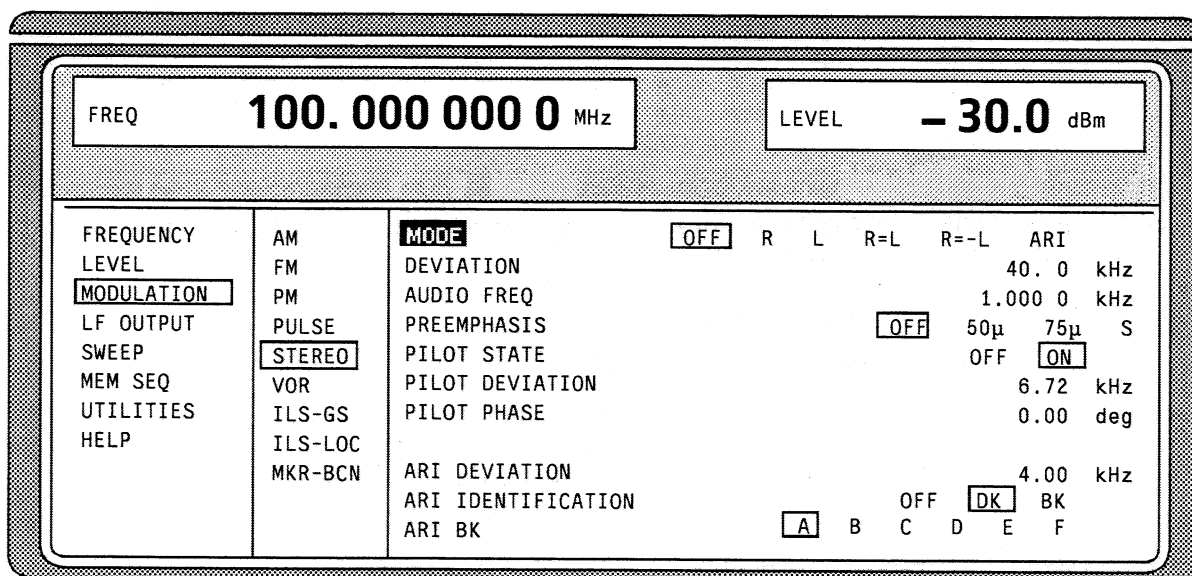

Fig. 2-32 Menu MODULATION-STEREO (preset setting), fitted with option SM-B6, multifunction generator

MODE

Selection of the operating mode.

OFF The stereo signal is switched off.

R Audio signal only in the right-hand channel.

L Audio signal only in the left-hand channel.

R = L Audio signals of same frequency and phase in both channels.

R = -L Audio signals of same frequency but opposite phase in both channels.

ARI Generation of 19-kHz pilot tone and ARI traffic channel signals.

IEC-bus short command :STER:STAT ON; SIGN AUD; AUD:MODE LEFT

DEVIATION

Input value of the frequency deviation of the STEREO-MPX signal without considering the pilot-tone content.

IEC-bus short command :STER 40kHz

AUDIO FREQ

Input value of the frequency of the audio signal.

IEC-bus short command :STER:AUD:FREQ 1kHz

PREEMPHASIS

Selection of the preemphasis of the audio signal.

50 us Preemphasis 50 µs

75 us Preemphasis 75 µs

OFF Preemphasis switched off

IEC-bus short command :STER:AUD:PRE OFF

PILOT STATE	Switching on/off the pilot tone. IEC-bus short command :STER:PIL:STAT OFF
PILOT DEVIATION	Input value of the pilot deviation. IEC-bus short command :STER:PIL 6270
PILOT PHASE	Input value of the phase of the pilot tone. The zero point of the suppressed 38-kHz subcarrier of the STEREO multiplex signal serves as phase reference. IEC-bus short command :STER:PIL:PHAS 0
ARI DEVIATION	Input value of the deviation content of the unmodulated 57-kHz-ARI subcarrier in the ARI operating mode. IEC-bus short command :STER:ARI 4kHz
ARI IDENTIFICATION	Selection between ARI broadcasting code (DK) and traffic area code (BK). OFF The area code and the broadcasting code are switched off. DK The broadcasting code is activated. The AM modulation depth of the broadcasting code (125 Hz) on the ARI subcarrier is $m = 0.3$. BK The area code is activated. The AM modulation depth of the area code chosen under ARI BK is $m = 0.6$. IEC-bus short commands :STER:SIGN ARI; ARI:TYPE DK
ARI BK	Selection of the standard traffic area codes. A Traffic area code A, 23.7500 Hz B Traffic area code B, 28.2738 Hz C Traffic area code C, 34.9265 Hz D Traffic area code D, 39.5833 Hz E Traffic area code E, 45.6731 Hz F Traffic area code F, 53.9773 Hz IEC-bus short commands :STER:SIGN ARI; ARI:TYPE BK; ARI:BK A

2.6.7 VOR / ILS Test Signals

By means of option SM-B6, multifunction generator, test signals for avionics systems

- VOR (VHF Omnidirectional Range),
- ILS (Instrument Landing System) and
- MKR-BCN (Marker Beacon) can be generated.

2.6.7.1 VOR Modulation

- Notes:**
- *The following modulations cannot be set simultaneously and deactivate one another:*
VOR and AM
VOR and PM if SOURCE PM = LFGEN2
VOR and FM if SOURCE FM = LFGEN2
 - *In the AM, FM, PM and LF-output menu the message "VOR" is displayed under LFGEN2 if the VOR modulation is activated.*

Menu selection: MODULATION-VOR

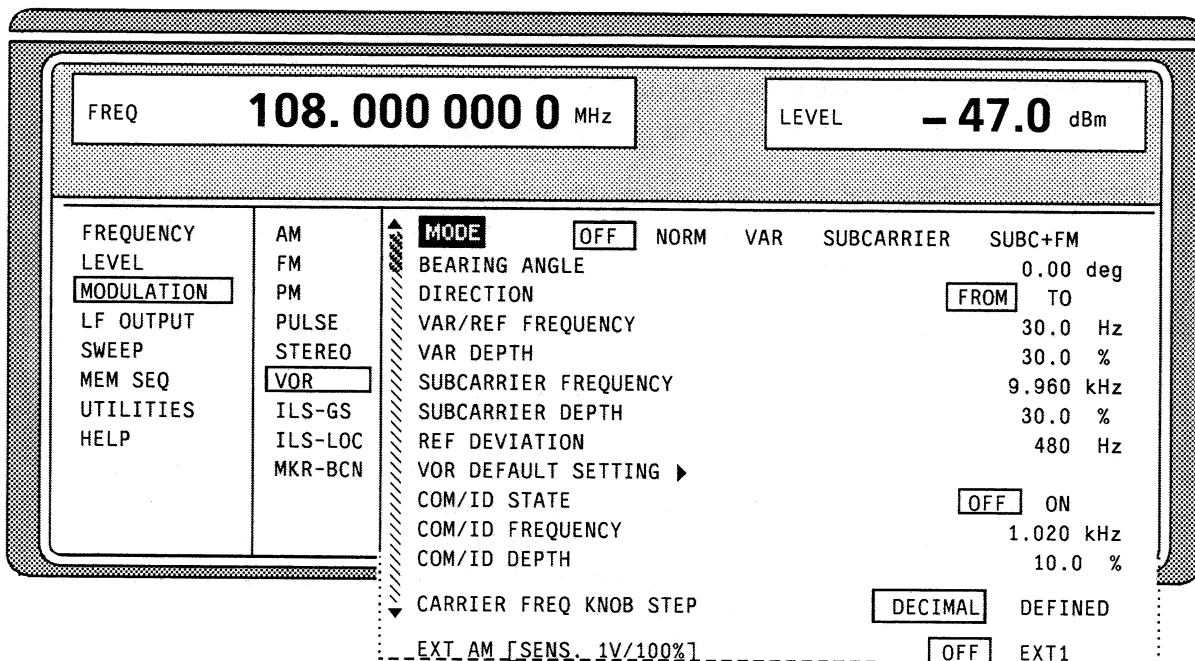

Fig. 2-33 Menu MODULATION-VOR (preset setting), fitted with option SM-B6, multifunction generator

- MODE** Selection of the VOR operating mode.
- OFF VOR modulation is switched off. In menus AM, FM, PM and LF-OUTPUT, the original setting is displayed under LFGEN2, the message "VOR" is eliminated.
 - NORM VOR modulation is activated.
 - VAR Amplitude modulation of the output signal with the 30-Hz signal content of the VOR signal. The modulation depth of the 30-Hz signal corresponds to the value set under VAR DEPTH.
 - SUBCARRIER Amplitude modulation of the output signal with the unmodulated 9960-Hz FM carrier of the VOR signal. The modulation depth corresponds to the value set under SUBCARRIER DEPTH.
 - SUBC + FM Amplitude modulation of the output signal with the frequency-modulated 9960-Hz carrier of the VOR signal. The frequency deviation corresponds to the value set under REF DEVIATION, the modulation depth to the value set under SUBCARRIER DEPTH.
- IEC-bus short command :VOR:STAT ON; MODE NORM
- BEARING ANGLE** Input value of the phase angle between the 30-Hz VAR signal and the 30-Hz reference signal.
- IEC-bus short command :VOR 0deg
- DIRECTION** Selection of the reference position of the phase information.
- FROM Selection of the beacon as a reference position. The angle set under BEARING ANGLE corresponds to the angle between the true north and the connection line between beacon and airplane.
 - TO Selection of the airplane position as a reference position. The angle set under BEARING ANGLE corresponds to the angle between the true north and the connection line between airplane and beacon.
- IEC-bus short command :VOR:DIR FROM
- VAR/REF FREQUENCY** Input value of the frequency of the VAR and the REF signal.
- IEC-bus short command :VOR:VAR:FREQ 30

- VAR DEPTH** Input value of the AM modulation depth of the (30-Hz) VAR signal.
IEC-bus short command :VOR:VAR 30PCT
- SUBCARRIER FREQUENCY** Input value of the frequency of the FM carrier.
IEC-bus short command :VOR:SUBC 9960
- SUBCARRIER DEPTH** Input value of the AM modulation depth of the FM carrier.
IEC-bus short command :VOR:SUBC:DEPT 30PCT
- REF DEVIATION** Input value of the frequency deviation of the REF signal on the FM carrier.
IEC-bus short command :VOR:REF 480
- VOR DEFAULT SETTING** Call the VOR default setting.
The default setting corresponds to the setting represented in Fig. 2-33 except for the MODE setting (= NORM). The selection of the CARRIER FREQ KNOB STEP parameters is not changed by calling this function.
IEC-bus short command :VOR:PRES
- COM/ID STATE** Switching on/off an additional communication/identification signal (COM/ID signal).
IEC-bus short command :VOR:COM ON
- COM/ID FREQUENCY** Input value of the frequency of the COM/ID signals.
IEC-bus short command :VOR:COM:FREQ 1020
- COM/ID DEPTH** Input value of the AM modulation depth of the COM/ID signals.
IEC-bus short command :VOR:COM:DEPT 10PCT
- CARRIER FREQ KNOB STEP** Selection of the variation of the carrier frequency via the rotary knob.
DECIMAL Decimal variation according to the current cursor position.
DEFINED Variation in predefined steps according to the standardized VOR transmitting frequencies (see table, values in MHz).
- Note:** If DEFINED is selected, the current RF frequency is automatically switched over to the next VOR transmitting frequency according to the table when switching on modulation VOR.

108.00	109.40	110.80	112.10	112.80	113.50	114.20	114.90	115.60	116.30	117.05	117.75
108.05	109.45	110.85	112.15	112.85	113.55	114.25	114.95	115.65	116.35	117.10	117.80
108.20	109.60	111.00	112.20	112.90	113.60	114.30	115.00	115.70	116.40	117.15	117.85
108.25	109.65	111.05	112.25	112.95	113.65	114.35	115.05	115.75	116.45	117.20	117.90
108.40	109.80	111.20	112.30	113.00	113.70	114.40	115.10	115.80	116.50	117.25	117.95
108.45	109.85	111.25	112.35	113.05	113.75	114.45	115.15	115.85	116.55	117.30	
108.60	110.00	111.40	112.40	113.10	113.80	114.50	115.20	115.90	116.60	117.35	
108.65	110.05	111.45	112.45	113.15	113.85	114.55	115.25	115.95	116.65	117.40	
108.80	110.20	111.60	112.50	113.20	113.90	114.60	115.30	116.00	116.75	117.45	
108.85	110.25	111.65	112.55	113.25	113.95	114.65	115.35	116.05	116.80	117.50	
108.00	110.40	111.80	112.60	113.30	114.00	114.70	115.40	116.10	116.85	117.55	
109.05	110.45	111.85	112.65	113.35	114.05	114.75	115.45	116.15	116.90	117.60	
109.20	110.60	112.00	112.70	113.40	114.10	114.80	115.50	116.20	116.95	117.65	
109.25	110.65	112.05	112.75	113.45	114.15	114.85	115.55	116.25	117.00	117.70	

EXT AM [SENS. 1V/100%] Switching on/off an external modulation signal via socket EXT1.

OFF External AM input (EXT1) switched off.

ON External AM input (EXT1) activated.

The sensitivity is 10 mV per percent modulation depth.

IEC-bus short command :VOR:SOUR INT2,EXT

Note: As automatic level monitoring of the external modulation signal is switched off in this operating mode, there can be an overmodulation as a function of the level of the external signal without a corresponding caution message being generated. In order to avoid an overmodulation, the peak value of the external signal is to be delimited corresponding to the sum of the modulation depths of the remaining VOR signal components.

2.6.7.2 ILS-Glide Slope Modulation (ILS-GS)

- Notes:**
- The following modulations cannot be set simultaneously and deactivate one another:
 ILS-GS and AM
 ILS-GS and PM if SOURCE PM = LFGEN2
 ILS-GS and FM if SOURCE FM = LFGEN2
 - In the AM, FM, PM and LF-output menu the message "ILS-GS" is displayed under LFGEN2 if the ILS-GS modulation is activated.
 - With setting CARRIER FREQ KNOB STEP = DEFINED, a change to modulation ILS-LOC automatically causes the RF frequency to be adapted to the localizer value which is coupled to the glide-slope setting.

Menu selection: MODULATION- ILS-GS

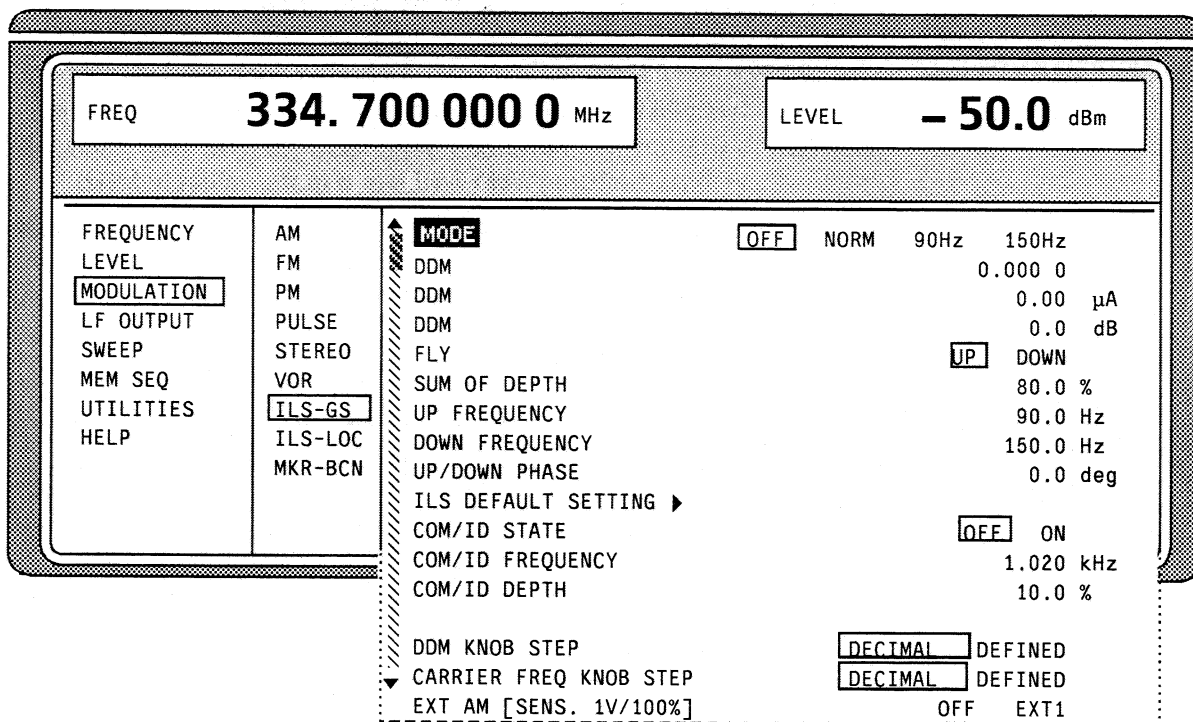

Fig. 2-34 Menu MODULATION-ILS-GS (preset setting), fitted with option SM-B6, multifunction generator

- MODE** Selection of the ILS-GS operating mode.
- OFF ILS-GS modulation is switched off.
 In menus AM, FM, PM and LF-OUTPUT, the original setting is displayed under LFGEN2, the message "ILS-GS" is eliminated.
 - NORM ILS-GS modulation is activated.

90 Hz Amplitude modulation of the output signal with the 90-Hz signal content of the ILS-GS signal. The modulation depth of the 90-Hz signal results from the settings of parameters SUM OF DEPTH (SOD) and DDM according to:

$$AM(90 \text{ Hz}) = 0.5 \times (\text{SOD} + \text{DDM} \times 100\%)$$

150 Hz Amplitude modulation of the output signal with the 150-Hz signal content of the ILS-GS signal. The modulation depth of the 150-Hz signal results from the settings of parameters SUM OF DEPTH (SOD) and DDM acc. to:

$$AM(150 \text{ Hz}) = 0.5 \times (\text{SOD} - \text{DDM} \times 100\%)$$

IEC-bus short command :*ILS:STAT ON; TYPE GS; MODE NORM*

DDM Difference in Depth of Modulation. Input value of the difference in depth of modulation between the 90-Hz and the 150-Hz tone of the ILS-GS modulation signal. The DDM value is calculated to formula (parameter UP/DOWN = DOWN):

$$\text{DDM} = [\text{AM}(90 \text{ Hz}) - \text{AM}(150 \text{ Hz})] / 100\%$$

A variation of the DDM value automatically leads to a variation of the value of the instrument current and the DDM value in dB.

IEC-bus short command :*ILS:DDM 0*

DDM Input value of the current of the ILS indicating instrument corresponding to the DDM value. A variation of the value of the instrument current automatically leads to a variation of the DDM value and the DDM value in dB. The value of the instrument current is calculated according to:

$$\text{DDM } \mu\text{A} = \text{DDM} \times 857.1 \mu\text{A}$$

IEC-bus short command :*ILS:DDM:CURR 0*

DDM Input of the DDM value in dB. A variation of the value automatically leads to a variation of the DDM value and the value of the instrument current. The dB value is calculated according to:

$$\text{DDM dB} = 20 \times \text{LOG} [(\text{SOD} + \text{DDM} \times 100\%) / (\text{SOD} - \text{DDM} \times 100\%)]$$

IEC-bus short command :*ILS:DDM:LOG 0*

FLY Selection between ILS-GS operating modes UP and DOWN. A change of the setting automatically changes the sign of the DDM value.

UP In operating mode UP, the 150-Hz modulation signal is predominant, the DDM value is positive.

DOWN In operating mode DOWN, the 90-Hz modulation signal is predominant, the DDM value is negative.

IEC-bus short command :*ILS:DDM:DIR UP*

SUM OF DEPTH Input value of the arithmetic sum of the modulation depths of the 90-Hz and 150-Hz ILS-GS signal contents. The RMS modulation depth of the sum signal depends on the phase setting of both modulation tones.

IEC-bus short command :*ILS:SOD 80PCT*

UP FREQ Input value of the modulation frequency of the antenna lobe arranged at the top.

IEC-bus short command :*ILS:ULOB 90*

DOWN FREQ Input value of the modulation freq. of the antenna lobe arranged at the bottom.

IEC-bus short command :*ILS:LLOB 150*

Note: *A variation of one of the two modulation frequencies causes an automatic adaptation of the other modulation frequency in such a way that a frequency-response ratio of 3:5 or 5:3 is maintained.*

UP/DOWN PHASE Input value of the phase between the modulation signals of the upper and lower antenna lobe. The zero point of the 150-Hz signal serves as a reference. The input is effected in degrees of the 150-Hz signal.

IEC-bus short command :*ILS:PHAS 0deg*

DEFAULT SETTING

Call the ILS-GS default setting. The default setting corresponds to the setting represented in Fig. 2-34 except for the MODE setting (= NORM). The selection of the CARRIER FREQ KNOB STEP parameter is not changed by calling this function.

IEC-bus short command :ILS:PRES

COM/ID STATE

Switching on/off an additional communication/identification signal (COM/ID-Signal).

IEC-bus short command :ILS:COM ON

COM/ID FREQUENCY

Input value of the frequency of the COM/ID signal.

IEC-bus short command :ILS:COM:FREQ 1020

COM/ID DEPTH

Input value of the AM modulation depth of the COM/ID signal.

IEC-bus short command :ILS:COM:DEPT 10PCT

DDM KNOB STEP

Selection of the variation of the DDM value via the rotary knob.

DECIMAL Decimal variation according to the current cursor position.

DEFINED Variation between the predefined DDM values:

- 0.4000
- 0.1750 (glide sector)
- 0.0910, - 0.0450
- 0.0000 (glide path)
- + 0.0450, + 0,0910
- + 0.1750 (glide sector)
- + 0.4000

CARRIER FREQ KNOB STEP

Selection of the variation of the carrier frequency via the rotary knob. The selection is effective for both ILS modulations.

DECIMAL Decimal variation according to the current cursor position.

DEFINED Variation in predefined steps according to the standardized GLIDE-SLOPE transmitting frequencies (see table).

Note: *If DEFINED is selected, the current RF frequency is automatically switched over to the next GLIDE-SLOPE transmitting frequency acc. to the table when switching on the modulation.*

LOC / GS (MHz)	LOC / GS (MHz)	LOC / GS (MHz)	LOC / GS (MHz)	LOC / GS (MHz)	LOC / GS (MHz)	LOC / GS (MHz)
108.10 / 334.70	108.70 / 330.50	109.30 / 332.00	109.90 / 333.80	110.50 / 329.60	111.10 / 331.70	111.70 / 333.50
108.15 / 334.55	108.75 / 330.35	109.35 / 331.85	109.95 / 333.65	110.55 / 329.45	111.15 / 331.55	111.75 / 333.35
108.30 / 334.10	108.90 / 329.30	109.50 / 332.60	110.10 / 334.40	110.70 / 330.20	111.30 / 332.30	111.90 / 331.10
108.35 / 333.95	108.95 / 329.15	109.55 / 332.45	110.15 / 334.25	110.75 / 330.05	111.35 / 332.15	111.95 / 330.95
108.50 / 329.90	109.10 / 331.40	109.70 / 333.20	110.30 / 335.00	110.90 / 330.80	111.50 / 332.90	
108.55 / 329.75	109.15 / 331.25	109.75 / 333.05	110.35 / 334.85	110.95 / 330.65	111.55 / 332.75	

EXT AM [SENS. 1V/100%]

Switching on/off an external modulation signal via socket EXT1.

OFF External AM input EXT1 switched off.

ON External AM input EXT1 activated.

The sensitivity is 10 mV per percent of modulation depth.

IEC-bus short command :ILS:SOUR INT2, EXT

Note: *As the automatic level monitoring of the external modulation signal is switched off in this operating mode, there can be an overmodulation as a function of the level of the external signal without a corresponding caution message being generated.*

In order to avoid an overmodulation, the peak value of the external signal is to be delimited corresponding to the sum of the modulation depths of the remaining ILS signal components.

2.6.7.3 ILS-Localizer Modulation (ILS-LOC)

- Notes:**
- The following modulations cannot be set simultaneously and deactivate one another:
ILS-LOC and AM
ILS-LOC and PM if SOURCE PM = LFGEN2
ILS-LOC and FM if SOURCE FM = LFGEN2
 - In the AM, FM, PM and LF-output menu the note "ILS-LOC" is displayed under LFGEN2 if the ILS-LOC modulation is activated.
 - With setting CARRIER FREQ KNOB STEP = DEFINED, a change to modulation ILS-GS automatically causes the RF frequency to be adapted to the glide-slope value which is coupled to the localizer setting.

Menu selection: MODULATION ILS-LOC

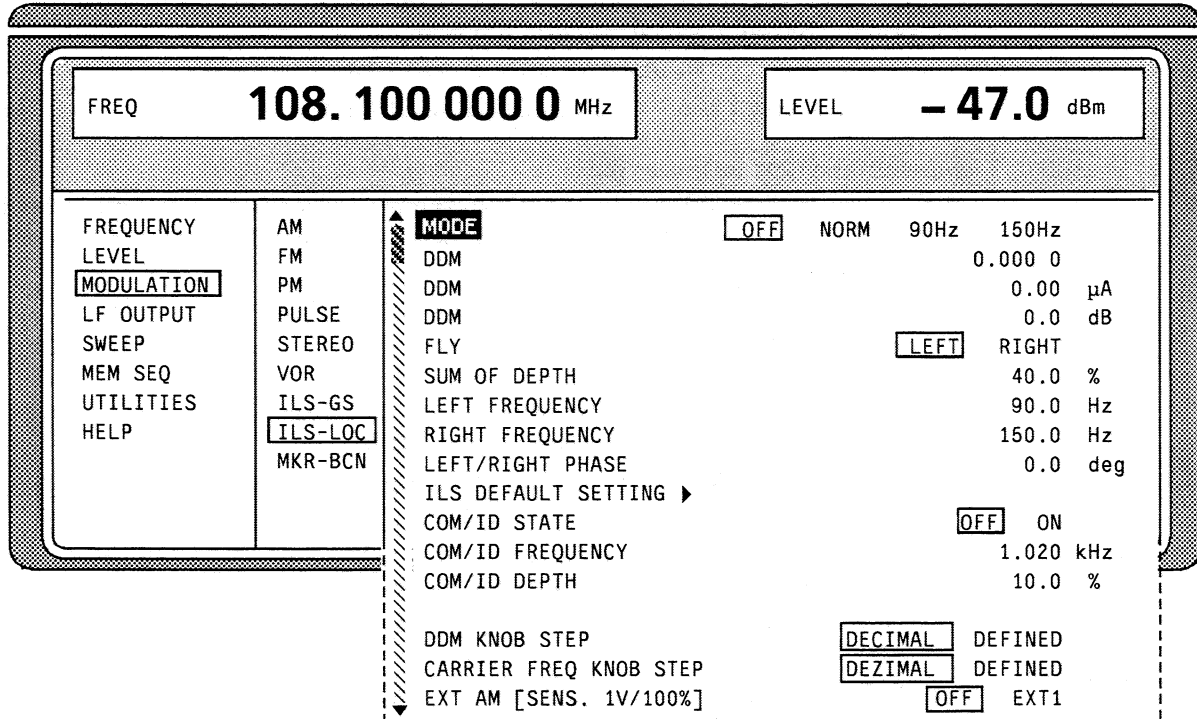

Fig. 2-35 Menu MODULATION-ILS-LOC (preset setting), fitted with option SM-B6, multifunction generator

MODE

Selection of the ILS-LOC operating mode.

OFF ILS-LOC modulation is switched off.
 In menus AM, FM, PM and LF-OUTPUT the original setting is displayed under LFGEN2, the note "ILS-LOC" is eliminated.

NORM ILS-LOC modulation is activated.

90 Hz Amplitude modulation of the output signal with the 90-Hz signal content of the ILS-LOC signal. The modulation depth of the 90-Hz signal is calculated from the settings of parameters SUM OF DEPTH (SOD) and DDM according to:

$$AM(90\text{ Hz}) = 0.5 \times (SOD + DDM \times 100\%)$$

150 Hz Amplitude modulation of the output signal with the 150-Hz signal content of the ILS-LOC signal. The modulation depth of the 150-Hz signal results from the settings of parameters SUM OF DEPTH (SOD) and DDM according to:

$$AM(150\text{ Hz}) = 0.5 \times (SOD - DDM \times 100\%)$$

IEC-bus short command :ILS:STAT ON; TYPE LOC; LOC:MODE NORM

DDM	<p><u>D</u>ifference in <u>D</u>epth of <u>M</u>odulation. Input value of the difference in depth of modulation between the 90-Hz and the 150-Hz tone of the ILS-LOC modulation signal. The DDM value is calculated according to the following formula (parameter LEFT/RIGHT = RIGHT) :</p> $\text{DDM} = [\text{AM}(90 \text{ Hz}) - \text{AM}(150 \text{ Hz})] / 100\%$ <p>If LEFT of parameter LEFT/RIGHT is selected, negative DDM values result with otherwise same setting. A variation of the DDM value automatically leads to a variation of the DDM value in dB and the value of the instrument current.</p> <p>IEC-bus short command : <i>ILS:LOC:DDM 0</i></p>
DDM	<p>Input value of the current of the ILS indicating instrument corresponding to the DDM value. A variation of the value of the instrument current automatically leads to a variation of the DDM value and the DDM value in dB. The value of the instrument current is calculated according to:</p> $\text{DDM } \mu\text{A} = \text{DDM} \times 857.1 \mu\text{A}$ <p>IEC-bus short command : <i>ILS:LOC:DDM:CURR 0</i></p>
DDM	<p>Input of the DDM value in dB. A variation of the DDM value in dB automatically leads to a variation of the value of the instrument current and of the DDM value. The dB value is calculated according to:</p> $\text{DDM dB} = 20 \times \text{LOG} [(\text{SOD} + \text{DDM} \times 100\%) / (\text{SOD} - \text{DDM} \times 100\%)]$ <p>IEC-bus short command : <i>LOC:DDM:LOG 0</i></p>
FLY	<p>Selection between ILS-LOC operating modes LEFT and RIGHT. A change of the setting automatically changes the sign of the DDM value.</p> <p>LEFT In the LEFT operating mode, the content of the 150-Hz modulation signal is predominant. The DDM value is negative.</p> <p>RIGHT In the RIGHT operating mode, the content of the 90-Hz modulation signal is predominant. The DDM value is positive.</p> <p>IEC-bus short command : <i>ILS:LOC:DDM:DIR LEFT</i></p>
SUM OF DEPTH	<p>Input value of the arithmetic sum of the modulation depths of 90-Hz and 150-Hz ILS-LOC signal contents. The RMS modulation depth depends on the phase setting of both modulation tones.</p> <p>IEC-bus short command : <i>ILS:LOC:SOD 40PCT</i></p>
LEFT FREQUENCY	<p>Input value of the modulation frequency of the antenna lobe arranged at the left viewed from the plane.</p> <p>IEC-bus short command : <i>ILS:LOC:LLOB 90</i></p>
RIGHT FREQUENCY	<p>Input value of the modulation frequency of the antenna lobe arranged at the right viewed from the plane.</p> <p>IEC-bus short command : <i>ILS:LOC:RLOB 150</i></p> <p>Note: <i>A variation of one of the two modulation frequencies causes an automatic adaptation of the other modulation frequency in such a way that a frequency-response ratio of 3:5 or 5:3 is maintained.</i></p>
LEFT/RIGHT PHASE	<p>Input value of the phase between the modulation signals of the left-hand and right-hand antenna lobe. The zero point of the 150-Hz signal serves as a reference. The input is effected in degrees of the 150-Hz signal.</p> <p>IEC-bus short command : <i>ILS:LOC:PHAS 0deg</i></p>

ILS DEFAULT SETTING	<p>Call the ILS-LOC default setting. The default setting corresponds to the setting represented in Fig. 2-35 except for the MODE setting (= NORM). The selection of the CARRIER FREQ KNOB STEP parameter is not changed by calling this function. IEC-bus short command :ILS:LOC:PRES</p>
COM/ID STATE	<p>Switching on/off an additional communication/identification signal (COM/ID-Signal). IEC-bus short command :ILS:LOC:COM ON</p>
COM/ID FREQUENCY	<p>Input value of the frequency of the COM/ID signal. IEC-bus short command :ILS:LOC:COM:FREQ 1020</p>
COM/ID DEPTH	<p>Input value of the AM modulation depth of the COM/ID signal. IEC-bus short command :ILS:LOC:COM:DEPT 10PCT</p>
DDM KNOB STEP	<p>Selection of the variation of the DDM value via the rotary knob. DECIMAL Decimal variation according to the current cursor position. DEFINED Variation between the predefined DDM values: - 0.2000, - 0.1550 (course sector) - 0.0930, - 0.0460 0.0000 (course line) + 0.0460, + 0.0930 + 0.1550 (course sector) + 0.2000</p>
CARRIER FREQ KNOB STEP	<p>Selection of the variation of the carrier frequency via the rotary knob. The selection is effective on both ILS modulations. DECIMAL Decimal variation according to the current cursor position. DEFINED Variation in predefined steps according to the standardized ILS-LOCALIZER transmitter frequencies (see table ILS-GS modulation). Note: <i>If DEFINED is selected, the current RF frequency is automatically switched over to the next LOCALIZER transmitter frequency according to the table when switching on the modulation.</i></p>
EXT AM [SENS. 1 V/100%]	<p>Switching on/off an external modulation signal via socket EXT1. OFF External AM input EXT1 switched off. ON External AM input EXT1 activated. The sensitivity is 10 mV per percent modulation depth. IEC-bus short command :ILS:SOUR INT2, EXT Note: <i>As automatic level monitoring of the external modulation signal is switched off in this operating mode, there can be an overmodulation as a function of the level of the external signal without a corresponding caution message being generated. In order to avoid an overmodulation, the peak value of the external signal is to be delimited corresponding to the sum of the modulation depths of the remaining ILS signal components.</i></p>

2.6.7.4 Marker Beacon

- Notes:**
- The following modulations cannot be set simultaneously and deactivate one another:
 MKR-BCN and AM, MKR-BCN and PM if SOURCE PM = LFGEN2
 MKR-BCN and FM if SOURCE FM = LFGEN2
 - In the AM, FM, PM and LF-output menu the note "MKR-BCN" is displayed under LFGEN2 if the MKR-BCN modulation is activated.

Menu selection: MODULATION-MKR-BCN

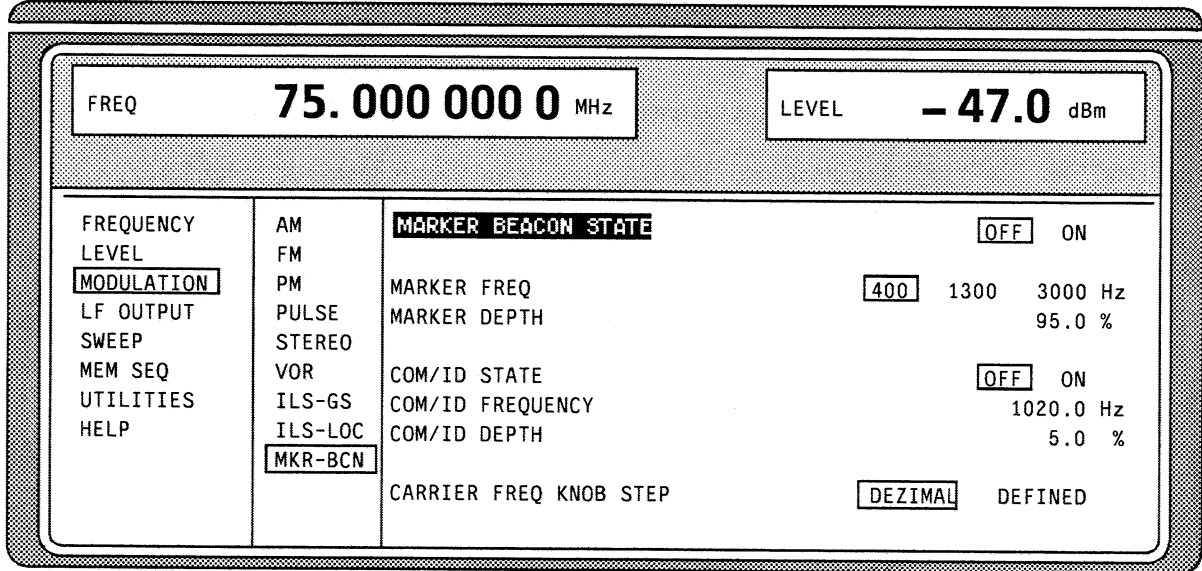

Fig. 2-36 Menu MODULATION-MKR-BCN (preset settings), fitted with option SM-B6, multifunction generator.

- MARKER BEACON STATE** Switching on and off the marker-beacon signal.
 IEC-bus short command :*MBE:STAT ON*
- MARKER FREQ** Selection of the frequency of the marker-beacon signal.
 IEC-bus short command :*MBE:FREQ 400*
- MARKER DEPTH** Input value of the modulation depth of the marker-beacon signal.
 IEC-bus short command :*MBE:DEPT 95PCT*
- COM/ID STATE** Switching on and off an additional communication/identification signal (COM/ID signal).
 IEC-bus short command :*MBE:COM ON*
- COM/ID FREQUENCY** Input value of the frequency of the COM/ID signal.
 IEC-bus short command :*MBE:COM:FREQ 1020*
- COM/ID DEPTH** Input value of the AM modulation depth of the COM/ID signal.
 IEC-bus short command :*MBE:COM:DEPT 5PCT*
- CARRIER FREQ KNOB STEP** Selection of the variation of the carrier frequency via the rotary knob.
 DECIMAL Decimal variation according to the current cursor position.
 DEFINED Variation in predefined steps according to the standardized marker beacon transmitter frequencies (s. table, value in MHz).
- Note:** If *DEFINED* is selected, the current RF frequency is automatically switched over to the next marker beacon transmitter frequency when switching on the modulation.

74.600	75.675	74.750	74.825	74.900	74.975	75.050	75.125	75.200	75.275	75.350
74.625	74.700	74.775	74.850	74.925	75.000	75.075	75.150	75.225	75.300	75.375
74.650	74.725	74.800	74.875	74.950	75.025	75.100	75.175	75.250	75.325	75.400

2.7 LF-Output

Depending on which options are fitted (cf. table 2-4), internal LF generator 1 and/or 2 are available as a signal source for the LF output.

Menu LF OUTPUT offers access to the settings of the LF output.

- Notes:**
- An alteration of the waveform or frequency of the internal modulation generators in the LF-output menu has a parallel effect on the modulation for which the respective generator has been selected as modulation source.
 - The SWEEP function of LF generator 2 can be activated in menu SWEEP-LF-GEN2.
 - Key [G/n] dB μ V switches the unit of the display / LF level output voltage setting to dBu.

Menu selection: LF OUTPUT

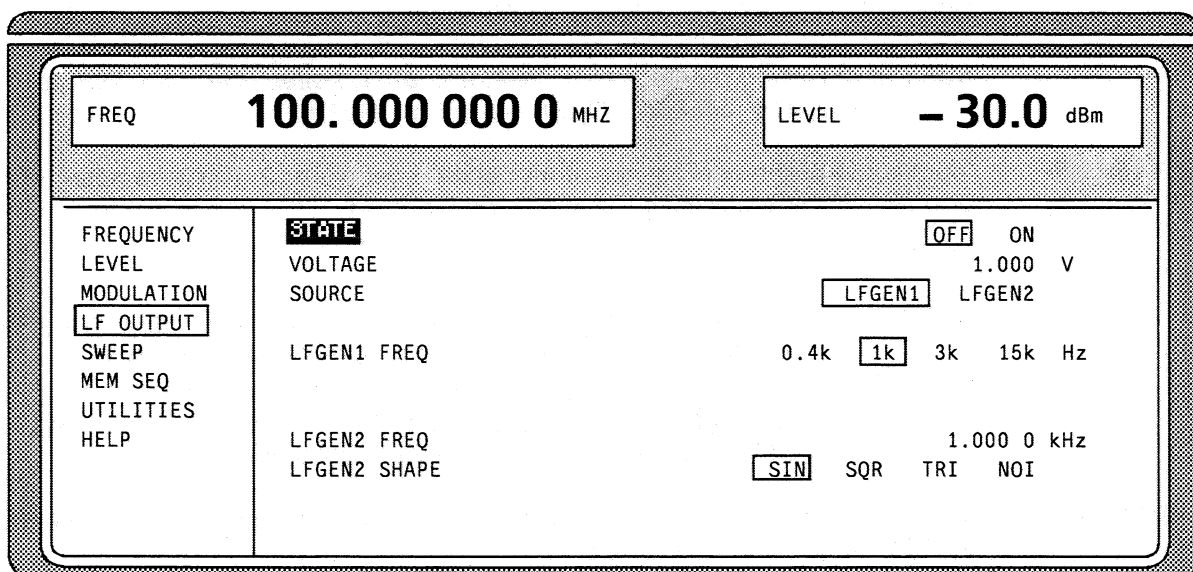

Fig. 2-37 Menu LF OUTPUT (preset setting), fitted with option SM-B6, multifunction generator

STATE Switching on/off the LF output. Parameter LF STATE has no influence on the modulation settings.

IEC-bus short command :OUTP2 ON

VOLTAGE Input value of the output voltage of the LF output. The input is effected in the form of a peak voltage. If no LF generator option is fitted, the constant output voltage of the standard generator ($V_S = 1\text{ V}$) is indicated.

IEC-bus short command :OUTP2: VOLT 1V

Notes: If LF generator 2 (LFGEN2) is selected as source and

- STEREO operating mode is activated, the voltage of the LF output depends on the setting of the wanted and the pilot deviation and cannot be changed in this menu. The output voltage is 6 dBu (1.55 V_{RMS} at 600 Ω) per 40 kHz of set sum deviation. The following is displayed:

VOLTAGE (STEREO) 6dBu / 40 kHz

- one of operating modes VOR, ILS-GS or ILS-LOC is activated, the input of the output voltage of the LF output is effected relative to the set sum modulation depth. The following is displayed, e.g. in the case of VOR modulation:

VOLTAGE (VOR/ILS) per 100% DEPTH 1.000 V

LF SOURCE	<p>Selection of the signal source for the LF output.</p> <p>IEC-bus short command :<i>OUTP2:SOUR 0</i> (Selection of LF generator 1) :OUTP2:SOUR 2 (Selection of LF generator 2)</p>
LFGEN1 FREQ	<p>Input value of the frequency of internal modulation generator 1.</p> <p>IEC-bus short command :<i>SOUR0:FREQ 1kHz</i></p>
LFGEN1 SHAPE	<p>Input value of the signal shape for modulation generator 1. The signal shape of modulation generator 1 can only be set if two modulation generator options are fitted.</p> <p>IEC-bus short command :<i>SOUR0:FUNC SIN</i></p>
LFGEN2 FREQ	<p>Input value of the frequency of internal modulation generator 2. This parameter is only displayed if a modulation generator option is fitted.</p> <p>IEC-bus short command :<i>SOUR2:FREQ 1kHz</i></p> <p><i>Note: In operating modes Stereo, VOR, ILS.. or LF-Sweep, the value indication is replaced by "STEREO", "VOR", "ILS.." or "SWEEP".</i></p>
LFGEN2 SHAPE	<p>Input value of the signal shape of modulation generator 2. This parameter is only displayed if a modulation generator option is fitted.</p> <p>IEC-bus short command :<i>SOUR2:FUNC SIN</i></p> <p>Notes:</p> <ul style="list-style-type: none"> - A selection of signal shape NOI in the LF-SWEEP operating mode automatically leads to this operating mode being aborted. - In operating modes STEREO, VOR, ILS.. an indication of this parameter is eliminated. Instead, a selection between STEREO OUTPUT MPX and PILOT is possible (see below).
STEREO OUTPUT	<p>Selection of the stereo signal at the LF output. This parameter is only displayed if STEREO modulation is activated.</p> <p>MPX Output of the complete STEREO-MPX signal.</p> <p>PILOT Output of the pilot tone.</p> <p>IEC-bus short commands :<i>STER:STAT ON;</i> :<i>OUTP2:SOUR 2;</i> :<i>OUTP2:STER MPX</i></p>

2.8 Sweep

The SMT offers a digital step-by-step sweep for parameters:

- RF frequency
- LF frequency
- RF level

In addition to the digital step-by-step sweep, an analog sweep for RF frequency and RF level is possible by switching on frequency or amplitude modulation with an internal saw tooth.

Setting a sweep is effected in five basic steps which are shown in the following example, the setting of a frequency sweep:

1. Set sweep range (START and STOP or CENTER and SPAN).
2. Select linear or logarithmic sequence (SPACING).
3. Set step width (STEP) and dwell time (DWELL).
4. Activate marker if desired (MARKER).
5. Switch on sweep (MODE set to AUTO, SINGLE or STEP).

2.8.1 Setting the Sweep Range (START, STOP, CENTER and SPAN)

The sweep range of the RF sweep can be entered in two different ways. Either by entering the START and STOP value or by entering CENTER and SPAN. Please observe that the two parameter sets influence one another. The influence is exerted in the following way:

- START frequency altered:
STOP = unaltered
CENTER = $(\text{START} + \text{STOP})/2$
SPAN = $(\text{STOP} - \text{START})$
- STOP frequency altered:
START = unaltered
CENTER = $(\text{START} + \text{STOP})/2$
SPAN = $(\text{STOP} - \text{START})$
- CENTER frequency altered:
SPAN = unaltered
START = $(\text{CENTER} - \text{SPAN}/2)$
STOP = $(\text{CENTER} + \text{SPAN}/2)$
- SPAN frequency altered:
CENTER = unaltered
START = $(\text{CENTER} - \text{SPAN}/2)$
STOP = $(\text{CENTER} + \text{SPAN}/2)$

2.8.2 Selecting the Sweep Run (SPACING LIN, LOG)

The sweep run, linear or logarithmic, can be selected using SPACING. For the RF and LF sweep, a linear or logarithmic run is possible. For level sweep, only the logarithmic run is possible.

With the logarithmic sweep, step width STEP is equal to a constant fraction of the present setting. The logarithmic step width is entered in unit % with RF or LF sweep, in unit dB with level sweep.

2.8.3 Operating Modes (MODE)

The following operating modes are available:

AUTO	<p>Sweep from the starting point to the stop point, with automatic restart at the starting point. If another sweep operating mode was activated prior to the AUTO operating mode, continuation is made from the current sweep setting (cf. Fig. 2-38). IEC-bus short commands:</p> <table border="0"> <tr> <td>RF sweep:</td> <td>LF sweep:</td> <td>Level sweep:</td> </tr> <tr> <td><i>FREQ:MODE SWE</i></td> <td><i>SOUR2:FREQ:MODE SWE</i></td> <td><i>POW:MODE SWE</i></td> </tr> <tr> <td><i>SWE:MODE AUTO</i></td> <td><i>SOUR2:SWE:MODE AUTO</i></td> <td><i>SWE:POW:MODE AUTO</i></td> </tr> <tr> <td><i>TRIG:SOUR AUTO</i></td> <td><i>TRIG2:SOUR AUTO</i></td> <td><i>TRIG:SOUR AUTO</i></td> </tr> </table>	RF sweep:	LF sweep:	Level sweep:	<i>FREQ:MODE SWE</i>	<i>SOUR2:FREQ:MODE SWE</i>	<i>POW:MODE SWE</i>	<i>SWE:MODE AUTO</i>	<i>SOUR2:SWE:MODE AUTO</i>	<i>SWE:POW:MODE AUTO</i>	<i>TRIG:SOUR AUTO</i>	<i>TRIG2:SOUR AUTO</i>	<i>TRIG:SOUR AUTO</i>
RF sweep:	LF sweep:	Level sweep:											
<i>FREQ:MODE SWE</i>	<i>SOUR2:FREQ:MODE SWE</i>	<i>POW:MODE SWE</i>											
<i>SWE:MODE AUTO</i>	<i>SOUR2:SWE:MODE AUTO</i>	<i>SWE:POW:MODE AUTO</i>											
<i>TRIG:SOUR AUTO</i>	<i>TRIG2:SOUR AUTO</i>	<i>TRIG:SOUR AUTO</i>											
SINGLE	<p>Single run from the starting point to the stop point. If SINGLE is selected, the run is not started yet. Function EXECUTE SINGLE SWEEP ▶ to be executed, which can be used to start the run, is displayed below the MODE line (cf. Fig. 2-39). IEC-bus short commands:</p> <table border="0"> <tr> <td>RF sweep:</td> <td>LF sweep:</td> <td>Level sweep:</td> </tr> <tr> <td><i>FREQ:MODE SWE</i></td> <td><i>SOUR2:FREQ:MODE SWE</i></td> <td><i>POW:MODE SWE</i></td> </tr> <tr> <td><i>SWE:MODE AUTO</i></td> <td><i>SOUR2:SWE:MODE AUTO</i></td> <td><i>SWE:POW:MODE AUTO</i></td> </tr> <tr> <td><i>TRIG:SOUR SING</i></td> <td><i>TRIG2:SOUR SING</i></td> <td><i>TRIG:SOUR SING</i></td> </tr> </table>	RF sweep:	LF sweep:	Level sweep:	<i>FREQ:MODE SWE</i>	<i>SOUR2:FREQ:MODE SWE</i>	<i>POW:MODE SWE</i>	<i>SWE:MODE AUTO</i>	<i>SOUR2:SWE:MODE AUTO</i>	<i>SWE:POW:MODE AUTO</i>	<i>TRIG:SOUR SING</i>	<i>TRIG2:SOUR SING</i>	<i>TRIG:SOUR SING</i>
RF sweep:	LF sweep:	Level sweep:											
<i>FREQ:MODE SWE</i>	<i>SOUR2:FREQ:MODE SWE</i>	<i>POW:MODE SWE</i>											
<i>SWE:MODE AUTO</i>	<i>SOUR2:SWE:MODE AUTO</i>	<i>SWE:POW:MODE AUTO</i>											
<i>TRIG:SOUR SING</i>	<i>TRIG2:SOUR SING</i>	<i>TRIG:SOUR SING</i>											
STEP	<p>Step-by-step, manual run within the sweep limits. Activating STEP stops a running sweep and the cursor wraps to the indication value of CURRENT. The sweep run can now be controlled upwards or downwards in discrete steps using the rotary knob or the numeric keys. IEC-bus short commands:</p> <table border="0"> <tr> <td>RF sweep:</td> <td>LF sweep:</td> <td>Level sweep:</td> </tr> <tr> <td><i>FREQ:MODE SWE</i></td> <td><i>SOUR2:FREQ:MODE SWE</i></td> <td><i>POW:MODE SWE</i></td> </tr> <tr> <td><i>SWE:MODE STEP</i></td> <td><i>SOUR2:SWE:MODE STEP</i></td> <td><i>SWE:POW:MODE STEP</i></td> </tr> <tr> <td><i>TRIG:SOUR SING</i></td> <td><i>TRIG2:SOUR SING</i></td> <td><i>TRIG:SOUR SING</i></td> </tr> </table>	RF sweep:	LF sweep:	Level sweep:	<i>FREQ:MODE SWE</i>	<i>SOUR2:FREQ:MODE SWE</i>	<i>POW:MODE SWE</i>	<i>SWE:MODE STEP</i>	<i>SOUR2:SWE:MODE STEP</i>	<i>SWE:POW:MODE STEP</i>	<i>TRIG:SOUR SING</i>	<i>TRIG2:SOUR SING</i>	<i>TRIG:SOUR SING</i>
RF sweep:	LF sweep:	Level sweep:											
<i>FREQ:MODE SWE</i>	<i>SOUR2:FREQ:MODE SWE</i>	<i>POW:MODE SWE</i>											
<i>SWE:MODE STEP</i>	<i>SOUR2:SWE:MODE STEP</i>	<i>SWE:POW:MODE STEP</i>											
<i>TRIG:SOUR SING</i>	<i>TRIG2:SOUR SING</i>	<i>TRIG:SOUR SING</i>											
EXT-SINGLE	<p>Single run from the starting point to the stop point as in the case of SINGLE, but triggered by an external trigger signal. IEC-bus short commands:</p> <table border="0"> <tr> <td>RF sweep:</td> <td>LF sweep:</td> <td>Level sweep:</td> </tr> <tr> <td><i>FREQ:MODE SWE</i></td> <td><i>SOUR2:FREQ:MODE SWE</i></td> <td><i>POW:MODE SWE</i></td> </tr> <tr> <td><i>SWE:MODE AUTO</i></td> <td><i>SOUR2:SWE:MODE AUTO</i></td> <td><i>SWE:POW:MODE AUTO</i></td> </tr> <tr> <td><i>TRIG:SOUR EXT</i></td> <td><i>TRIG2:SOUR EXT</i></td> <td><i>TRIG:SOUR EXT</i></td> </tr> </table>	RF sweep:	LF sweep:	Level sweep:	<i>FREQ:MODE SWE</i>	<i>SOUR2:FREQ:MODE SWE</i>	<i>POW:MODE SWE</i>	<i>SWE:MODE AUTO</i>	<i>SOUR2:SWE:MODE AUTO</i>	<i>SWE:POW:MODE AUTO</i>	<i>TRIG:SOUR EXT</i>	<i>TRIG2:SOUR EXT</i>	<i>TRIG:SOUR EXT</i>
RF sweep:	LF sweep:	Level sweep:											
<i>FREQ:MODE SWE</i>	<i>SOUR2:FREQ:MODE SWE</i>	<i>POW:MODE SWE</i>											
<i>SWE:MODE AUTO</i>	<i>SOUR2:SWE:MODE AUTO</i>	<i>SWE:POW:MODE AUTO</i>											
<i>TRIG:SOUR EXT</i>	<i>TRIG2:SOUR EXT</i>	<i>TRIG:SOUR EXT</i>											
EXT-STEP	<p>Step-by-step run by means of the external trigger signal. Each trigger event triggers a single step. IEC-bus short commands:</p> <table border="0"> <tr> <td>RF sweep:</td> <td>LF sweep:</td> <td>Level sweep:</td> </tr> <tr> <td><i>FREQ:MODE SWE</i></td> <td><i>SOUR2:FREQ:MODE SWE</i></td> <td><i>POW:MODE SWE</i></td> </tr> <tr> <td><i>SWE:MODE STEP</i></td> <td><i>SOUR2:SWE:MODE STEP</i></td> <td><i>SWE:POW:MODE STEP</i></td> </tr> <tr> <td><i>TRIG:SOUR EXT</i></td> <td><i>TRIG2:SOUR EXT</i></td> <td><i>TRIG:SOUR EXT</i></td> </tr> </table>	RF sweep:	LF sweep:	Level sweep:	<i>FREQ:MODE SWE</i>	<i>SOUR2:FREQ:MODE SWE</i>	<i>POW:MODE SWE</i>	<i>SWE:MODE STEP</i>	<i>SOUR2:SWE:MODE STEP</i>	<i>SWE:POW:MODE STEP</i>	<i>TRIG:SOUR EXT</i>	<i>TRIG2:SOUR EXT</i>	<i>TRIG:SOUR EXT</i>
RF sweep:	LF sweep:	Level sweep:											
<i>FREQ:MODE SWE</i>	<i>SOUR2:FREQ:MODE SWE</i>	<i>POW:MODE SWE</i>											
<i>SWE:MODE STEP</i>	<i>SOUR2:SWE:MODE STEP</i>	<i>SWE:POW:MODE STEP</i>											
<i>TRIG:SOUR EXT</i>	<i>TRIG2:SOUR EXT</i>	<i>TRIG:SOUR EXT</i>											
OFF	<p>The sweep operating mode is switched off. IEC-bus short commands:</p> <table border="0"> <tr> <td>RF sweep:</td> <td>LF sweep:</td> <td>Level sweep:</td> </tr> <tr> <td><i>FREQ:MODE CW</i></td> <td><i>SOUR2:FREQ:MODE CW</i></td> <td><i>POW:MODE CW</i></td> </tr> </table>	RF sweep:	LF sweep:	Level sweep:	<i>FREQ:MODE CW</i>	<i>SOUR2:FREQ:MODE CW</i>	<i>POW:MODE CW</i>						
RF sweep:	LF sweep:	Level sweep:											
<i>FREQ:MODE CW</i>	<i>SOUR2:FREQ:MODE CW</i>	<i>POW:MODE CW</i>											

2.8.4 Trigger Input

An external signal at the rear input triggers the sweep in the EXT-SINGLE and EXT-STEP operating modes. The polarity of the active trigger edge can be set in menu UTILITIES - AUX I/O EXT TRIG SLOPE .

2.8.5 Sweep Outputs

Outputs X-AXIS, BLANK and MARKER are available at the rear of the instrument to control and trigger oscilloscopes or XY recorders.

X-AXIS With sweep switched on, this output supplies a voltage ramp of 0...10 V for the X-deflection of an oscilloscope or an XY recorder.

BLANK This output supplies a signal (0V/5V) to trigger and blank an oscilloscope or for the PEN LIFT control of an XY recorder. The polarity and the period of the signal can be set under UTILITIES - AUX I/O - BLANK POLARITY and - BLANK TIME.

MARKER This output becomes active when the sweep run has reached the mark. The MARKER signal can be used for the brightness control of an oscilloscope. Up to three marks can be set in order to mark certain positions in the sweep run. The polarity of the signal can be set in menu UTILITIES - AUX I/O - MARKER POLARITY. The period of the active signal is equal to the dwell time (DWELL) of a step.

Signal examples:

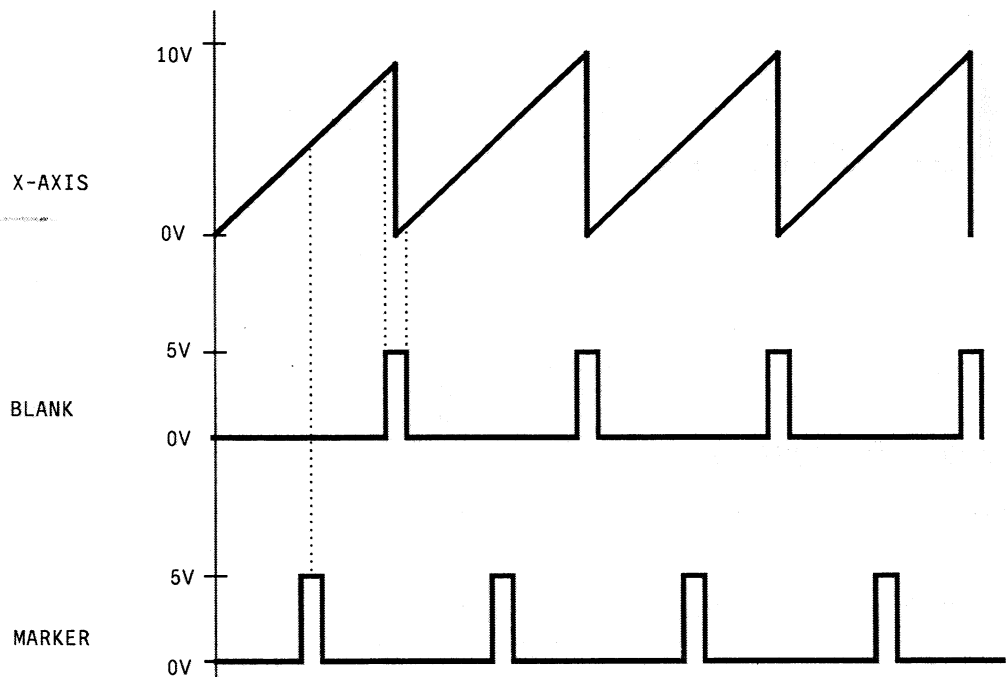

Fig. 2-38 Signal example sweep: MODE = AUTO, BLANK TIME = NORMAL

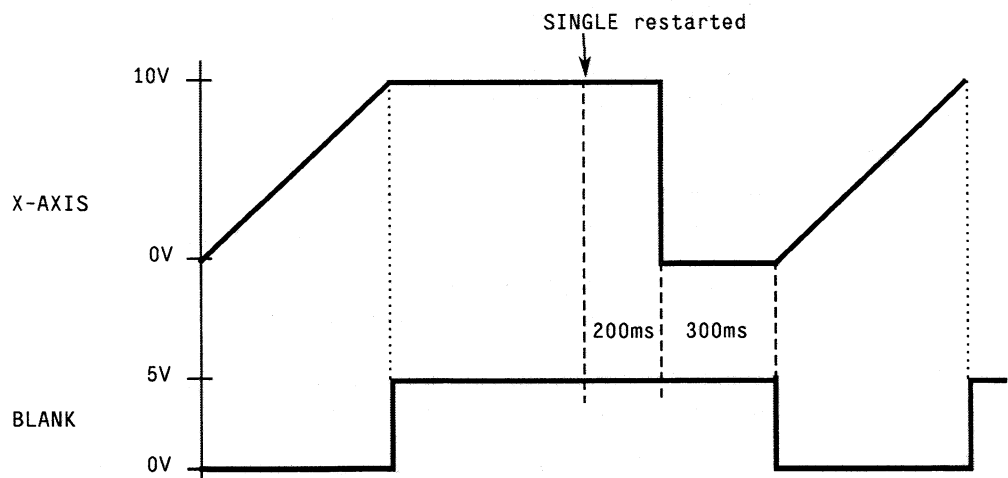

Fig. 2-39 Signal example sweep: MODE = SINGLE, BLANK TIME = LONG

2.8.6 RF-Sweep

Menu SWEEP - FREQ offers access to settings for RF sweep.

Menu selection: SWEEP - FREQ

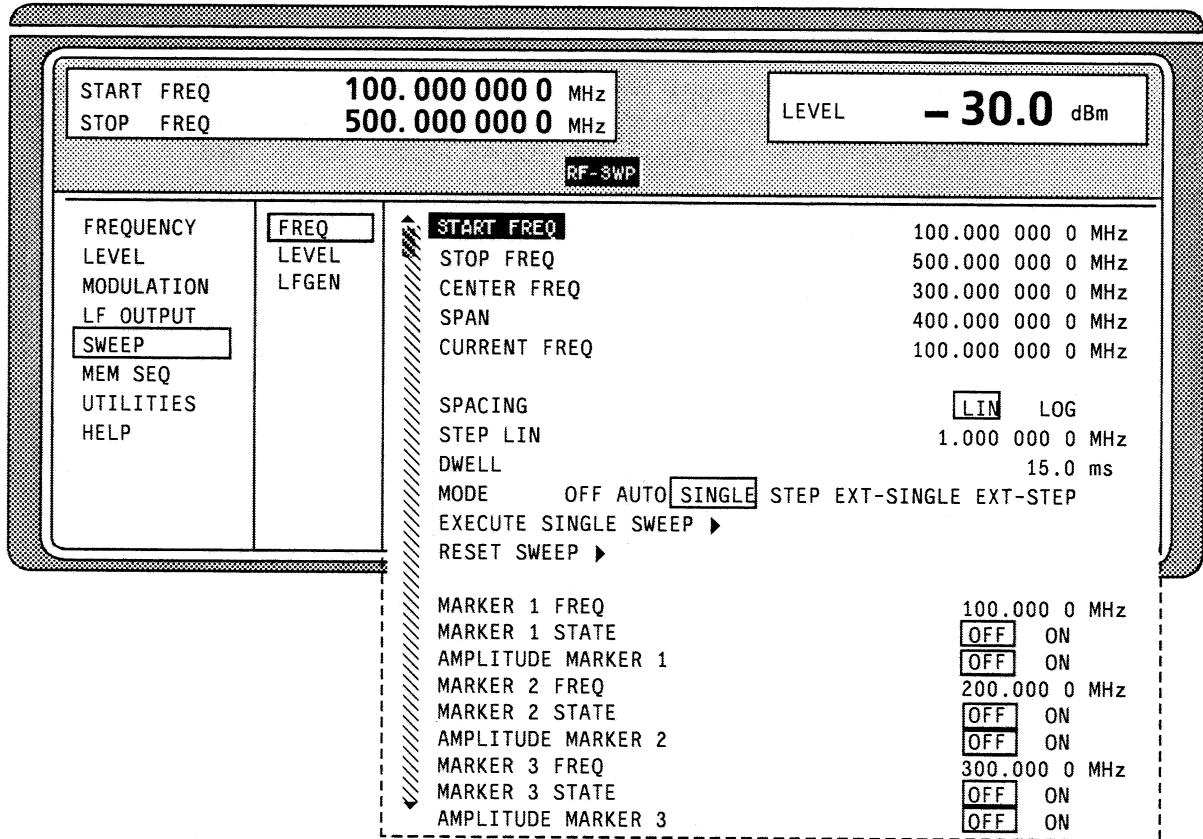

Fig. 2-40 Menu SWEEP - FREQ

- START FREQ** Input value of the starting frequency.
IEC-bus short command :*FREQ:STAR 100MHz*
- STOP FREQ** Input value of the stop frequency.
IEC-bus short command :*FREQ:STOP 500MHz*
- CENTER FREQ** Input value of the center frequency.
IEC-bus short command :*FREQ:CENT 300MHz*
- SPAN** Input value of the span.
IEC-bus short command :*FREQ:SPAN 100MHz*
- CURRENT FREQ** Indication of the current frequency value.
Operating mode STEP: Input value of frequency.
- STEP LIN (LOG)** Input value of the step width. Depending on whether SPACING LIN or LOG is selected, STEP LIN or LOG is displayed.
IEC-bus short command :*SWE:STEP:LIN 1MHz*
- DWELL** Input value of the dwell time per step
IEC-bus short command :*SWE:DWEL 10ms*
- SPACING** Selection of the sweep run, linear or logarithmic.
IEC-bus short command :*SWE:SPAC LIN*
- MODE** Selection of the sweep operating mode (cf. Section 2.8.3).
IEC-bus short command :*FREQ:MODE SWE; :SWE:MODE AUTO*
:TRIG:SOUR SING

- EXECUTE SINGLE SWEEP ▶** Starts a single sweep run. This action to be executed is only indicated and is only effective if MODE SINGLE has been selected.
IEC-bus short command :TRIG
- RESET ▶** Sets the starting frequency.
IEC-bus short command :ABOR
- MARKER 1 FREQ**
MARKER 2 FREQ
MARKER 3 FREQ Input value of the frequency for the marker selected.
IEC-bus short command :MARK1:FREQ 100MHZ
- MARKER 1 STATE**
MARKER 2 STATE
MARKER 3 STATE Switching on/off the marker selected.
IEC-bus short command :MARK1 OFF
- AMPLITUDE MARKER 1**
AMPLITUDE MARKER 2
AMPLITUDE MARKER 3 Switching on/off the amplitude marker selected.
OFF Amplitude marker is switched off.
ON Amplitude marker is switched on. On reaching the mark the output level is reduced by 1 dB.
IEC-bus short command :MARK1:AMPL OFF

2.8.7 LEVEL Sweep

Menu SWEEP - LEVEL offers access to settings for LEVEL sweep.

Menu selection: SWEEP - LEVEL

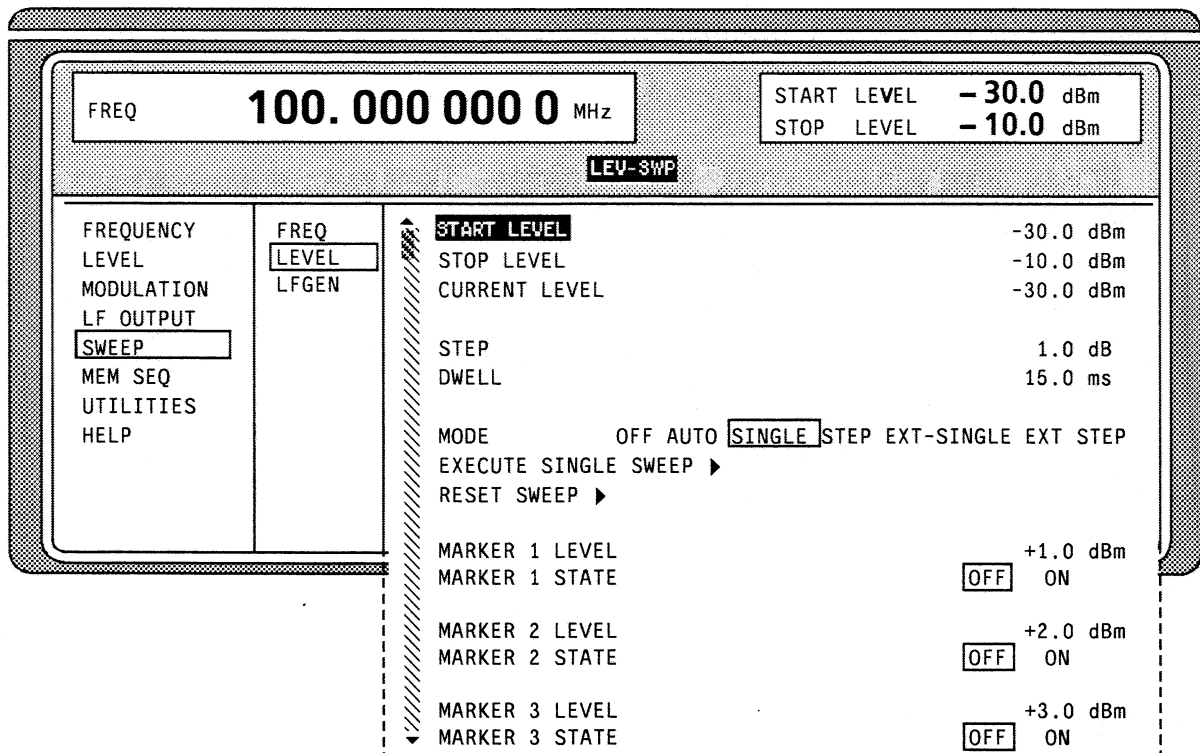

Fig. 2-41 Menu SWEEP - LEVEL

- START LEVEL** Input value of the starting level.
IEC-bus short command :POW:STAR -30DBM
- STOP LEVEL** Input value of the stop level.
IEC-bus short command :POW:STOP -10DBM

CURRENT LEVEL	Indication of the current level Operating mode STEP: Input value of level.
STEP	Input value of the step width. IEC-bus short command :SWE:POW:STEP 1DB
DWELL	Input value of the dwell time per step. IEC-bus short command :SWE:POW:DWEL 10ms
MODE	Selection of the sweep operating mode (cf. Section 2.8.3). IEC-bus short command :POW:MODE SWE; :SWE:POW:MODE AUTO; :TRIG:SOUR SING
EXECUTE SINGLE SWEEP ▶	Starts a single sweep run. This action to be executed is only indicated and is only effective if MODE SINGLE is selected. IEC-bus short command :TRIG
RESET ▶	Sets the starting level. IEC-bus short command :ABOR
MARKER 1 LEVEL MARKER 2 LEVEL MARKER 3 LEVEL	Input value of the level for the marker selected. IEC-bus short command :MARK1:PSW:POW 0dBm
MARKER 1 STATE MARKER 2 STATE MARKER 3 STATE	Switching on/off the marker selected. IEC-bus short command :MARK1:PSW OFF

2.8.8 LF-Sweep

Menu SWEEP - LF GEN2 offers access to settings for LF sweep.

Note: Settings LF SWEEP and SOURCE LFGEN2 SHAPE NOI deactivate one another.

Menu selection: SWEEP - LF GEN2

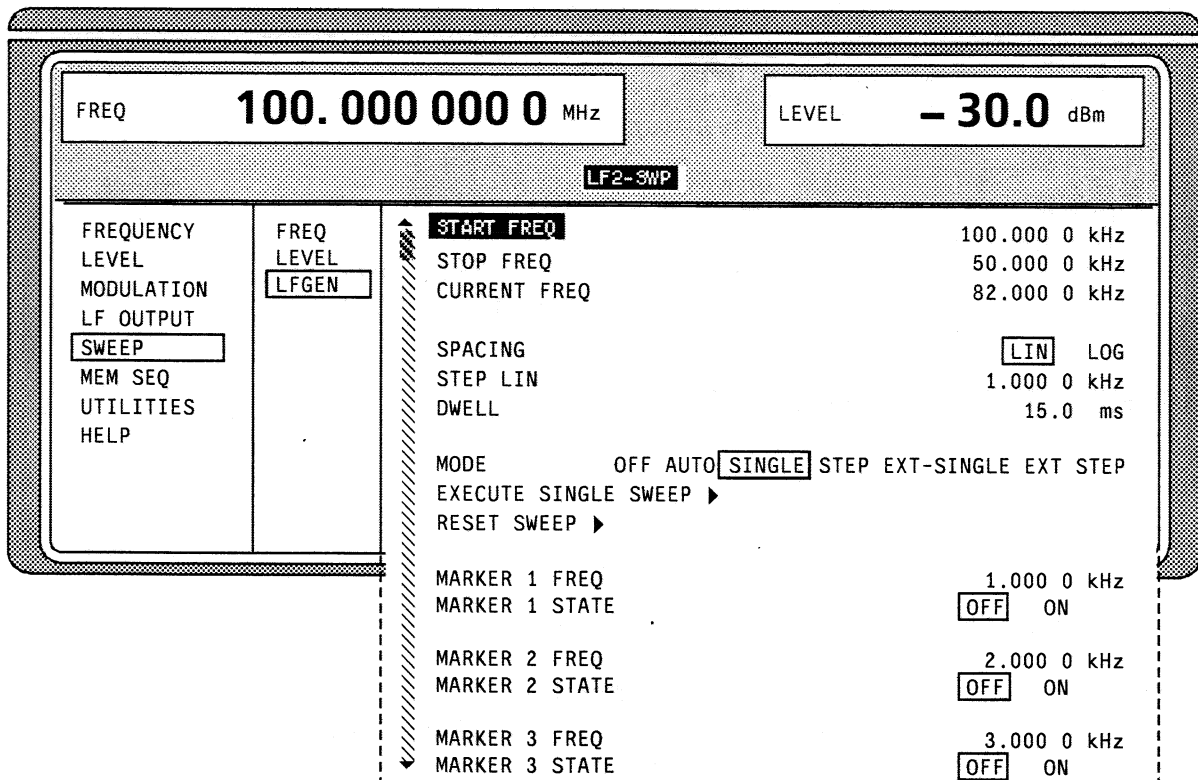

Fig. 2-42 Menu SWEEP - LF GEN

START FREQ	Input value of the starting frequency. IEC-bus short command : <i>SOUR2:FREQ:STAR 100kHz</i>
STOP FREQ	Input value of the stop frequency. IEC-bus short command : <i>SOUR2:FREQ:STOP 50kHz</i>
CURRENT FREQ	Indication of the current frequency value. Operating mode STEP: Input value of frequency.
STEP	Input value of the step width. IEC-bus short command : <i>SOUR2:SWE:STEP:LIN 1kHz</i>
DWELL	Input value of the dwell time per step. IEC-bus short command : <i>SOUR2:SWE:DWEL 10ms</i>
SPACING	Selection of the sweep run, linear or logarithmic. IEC-bus short command : <i>SOUR2:SWE:SPAC LIN</i>
MODE	Selection of the sweep operating mode (cf. Section 2.8.3). IEC-bus short command : <i>SOUR2:SWE:MODE AUTO; :TRIG:SOUR SING</i>
EXECUTE SINGLE SWEEP ▶	Starts a single sweep run. This action to be executed is only indicated and is only effective if MODE SINGLE is selected. IEC-bus short command : <i>TRIG</i>
RESET SWEEP ▶	Sets the starting frequency. IEC-bus short command : <i>ABOR</i>
MARKER 1 FREQ MARKER 2 FREQ MARKER 3 FREQ	Input value of the frequency for the marker selected. IEC-bus short command : <i>SOUR2:MARK1:FREQ 1kHz</i>
MARKER 1 STATE MARKER 2 STATE MARKER 3 STATE	Switching on/off the marker selected, IEC-bus short command : <i>SOUR2:MARK1 OFF</i>

2.9 Memory Sequence

In the memory-sequence operating mode the instrument automatically services a list with stored instrument settings. Memory locations 1 to 50, which are loaded using SAVE and whose stored settings are called either separately using RECALL or automatically and subsequently in the SEQUENCE mode, are available.

The list is continuously serviced from the beginning to the end with a continual index. The order of the memories to be passed through is arbitrary. Each setting can be assigned a freely selectable dwell time. The dwell time determines the duration of the setting, its minimal value is 50 ms, its maximal value 60 sec.

The list is divided up into 3 columns for list index, memory location number (Memory) and dwell time (Dwell). The beginning of the list has index 1.

Table 2-5 MEMORY SEQUENCE; Example of a list

Index	Memory	Dwell
001	09	50.0 ms
002	02	50.0 ms
003	01	75.0 ms
004	10	75.0 ms
...

Up to 10 sequence lists can be created. The total number of possible list elements is maximally 256. I.e., a list can have 256 entries at the most, or less if several lists have been created.

Each list is identified by a separate name and selected via this name. A detailed description how to process the lists can be found in Section 2.2.4, List Editor.

Note: *Frequently changing the level in the operating mode MEMORY SEQUENCE can stress the mechanically switched attenuator. The attenuator is also actuated when AM is switched on or off. For this reason we recommend that you make use of the non-interrupting level setting as much as possible and that you use the setting AM 0% instead of switching AM off.*

Operating Modes (MODE)

The following operating modes are available:

AUTO Run from the beginning to the end of the list with automatic restart at the beginning. If another mode was activated prior to the AUTO operating mode, continuation is made from the current index.

IEC-bus short commands `SYST:MODE MSEQ; :SYST:MSEQ:MODE AUTO`
`TRIG:MSEQ:SOUR AUTO`

SINGLE Single run from the beginning to the end of the list. If SINGLE is selected, the run is not yet started. Below the MODE line, function EXECUTE SINGLE SEQUENCE ▶ to be executed is displayed which can be used to start the run.

IEC-bus short commands `SYST:MODE MSEQ; :SYST:MSEQ:MODE AUTO`
`TRIG:MSEQ:SOUR SING`

- STEP** Step-by-step manual processing of the list. Activating STEP stops an automatic run and the cursor wraps to the indication value of CURRENT INDEX. The list can now be passed through upwards or downwards step by step using the rotary knob.
IEC-bus short commands *SYST:MODE MSEQ; :SYST:MSEQ:MODE STEP*
TRIG:MSEQ:SOUR SING
- EXT-SINGLE** Single run from the beginning to the end of the list as with SINGLE, but triggered by an external trigger signal.
IEC-bus short commands *SYST:MODE MSEQ; :SYST:MSEQ:MODE AUTO*
TRIG:MSEQ:SOUR EXT
- EXT-STEP** Step-by-step run using the external trigger signal. Each trigger event triggers a single step.
IEC-bus short commands *SYST:MODE MSEQ; :SYST:MSEQ:MODE STEP*
TRIG:MSEQ:SOUR EXT
- OFF** Operating mode MEMORY SEQUENCE is switched off.
IEC-bus short commands *SYST:MODE FIX*

External Trigger

An external signal at the rear input [TRIGGER] triggers the MEMORY SEQUENCE in the EXT-SINGLE and EXT-STEP operating modes. The polarity of the active trigger edge can be set in the UTILITIES - AUX I/O - EXT TRIG SLOPE menu.

Menu MEM SEQ with the two menu pages OPERATION and EDIT offers access to the memory-sequence operating mode.

Menu selection: MEM SEQ

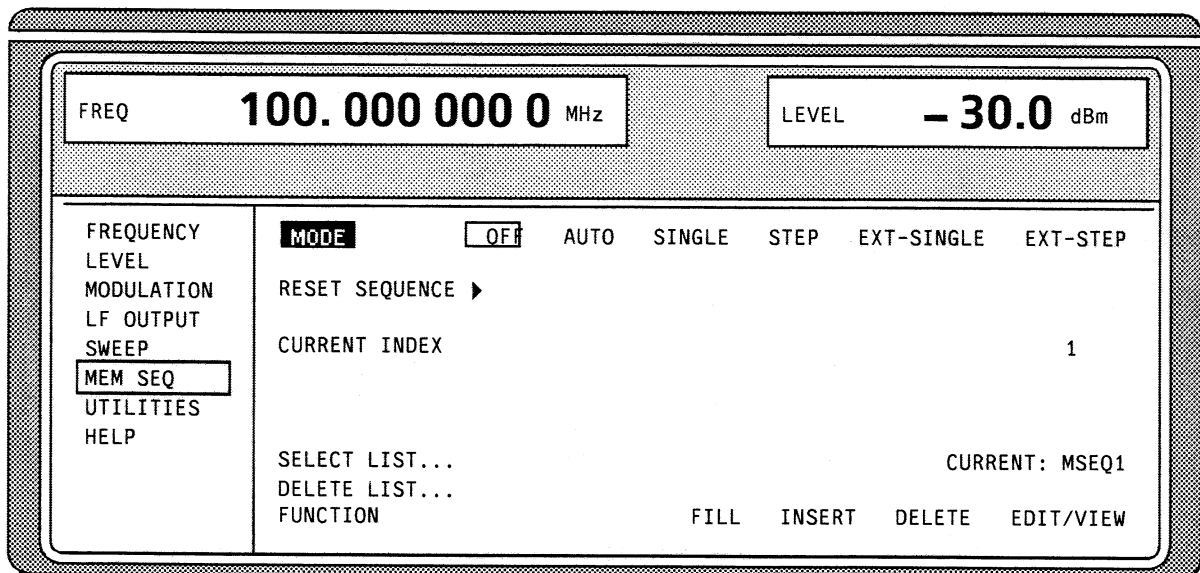

Fig. 2-43 Menu MEM SEQ — OPERATION page (preset setting)

MODE Selection of the operating mode; setting the operating mode regards various command systems at the IEC bus (cf. above).

- EXECUTE SINGLE SEQUENCE ▶** Starts the single run of a memory sequence. This menu option is only visible if **MODE SINGLE** is selected.
IEC-bus short command :*TRIG:MSEQ*

- RESET ▶** Wrap to the beginning of the list.
IEC-bus short command :*ABOR:MSEQ*

- CURRENT INDEX** Indication of the current list index. Setting value of the current list index in the **MODE STEP** operating mode.

- SELECT LIST...** Selection of a list or generation of a new list (cf. Section 2.2.4, List Editor).
IEC-bus short command :*SYST:MSEQ:SEL "MSEQ1"*

- DELETE LIST...** Deletion of a list (cf. Section 2.2.4, List Editor).
IEC-bus short command :*SYST:MSEQ:DEL "MSEQ2"*

- FUNCTION** Selection of the editor functions to process the selected list (cf. Section 2.2.4, List Editor).
IEC-bus short command :*SYST:MSEQ 2, 4...; DWEL 50ms, 60ms...*

The second page of menu **MEM SEQ**, the **EDIT** page, is automatically activated if one of the editor functions of the **FUNCTION** line is selected. The list which is entered as **CURRENT LIST** in the **SELECT LIST** line is shown.

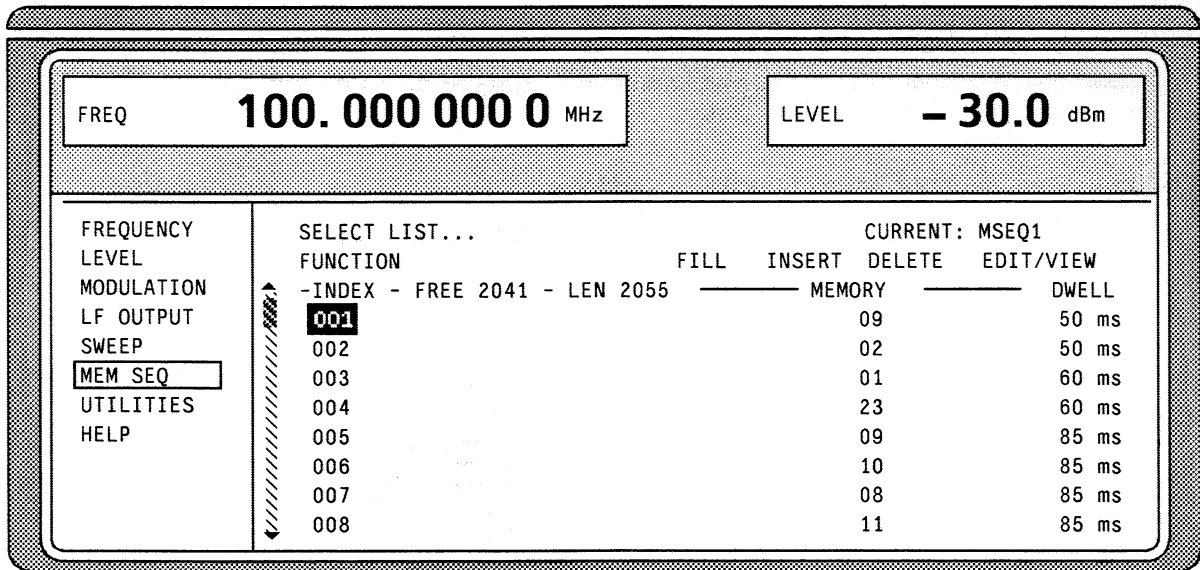

Fig. 2-44 Menu **MEM SEQ** — **EDIT** page

- INDEX** Index of the list.
- FREE** Indication of the list entries still vacant.
- LEN** Length of the current list.
- MEMORY** Parameter: number of memory location; range 1 to 50.
- DWELL** Parameter: dwell time; specified range 50 ms to 60 sec, step width 1 ms.

2.10 Utilities

The UTILITIES menu contains submenus for general functions which do not directly relate to the signal generation.

2.10.1 IEC-Bus Address (SYSTEM-GPIB)

Submenu SYSTEM-GPIB offers access to the remote-control address. The setting range is 0 to 30. At the point of delivery address 28 is set.

Menu selection: UTILITIES - SYSTEM - GPIB

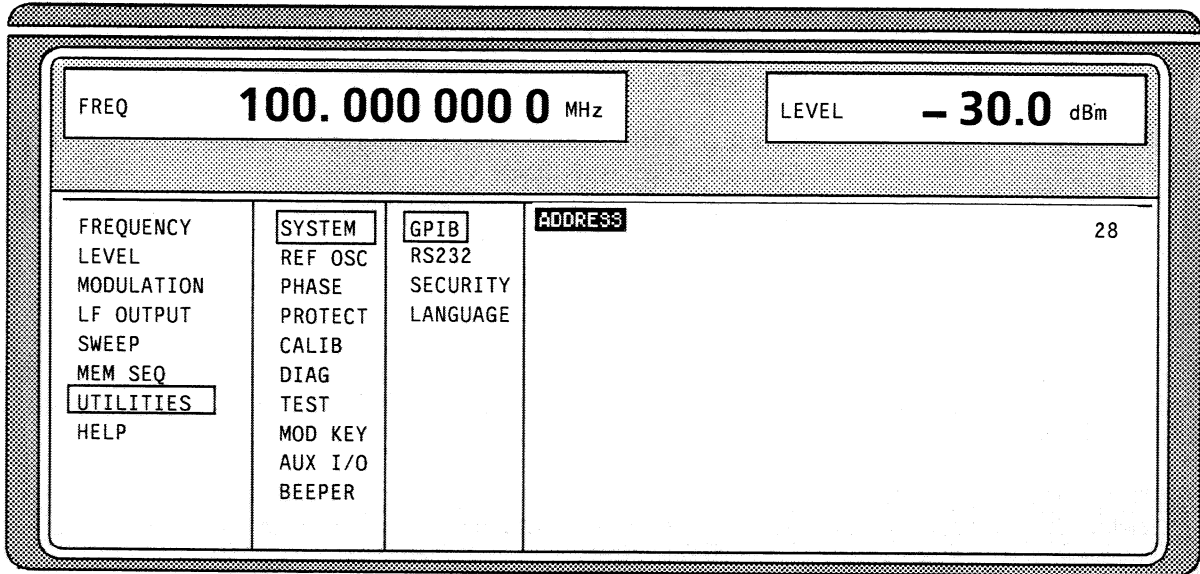

Fig. 2-45 Menu UTILITIES - SYSTEM - GPIB

ADDRESS Input value of the IEC-bus address
IEC-bus short command :SYST:COMM:GPIB:ADDR 25

2.10.2 Parameter of the RS232 Interface (SYSTEM RS232)

Submenu SYSTEM-RS232 offers access to the configuration of the RS-232 interface. The pin assignment of the interface corresponds to the one of a PC.

Menu selection: UTILITIES - SYSTEM-RS232

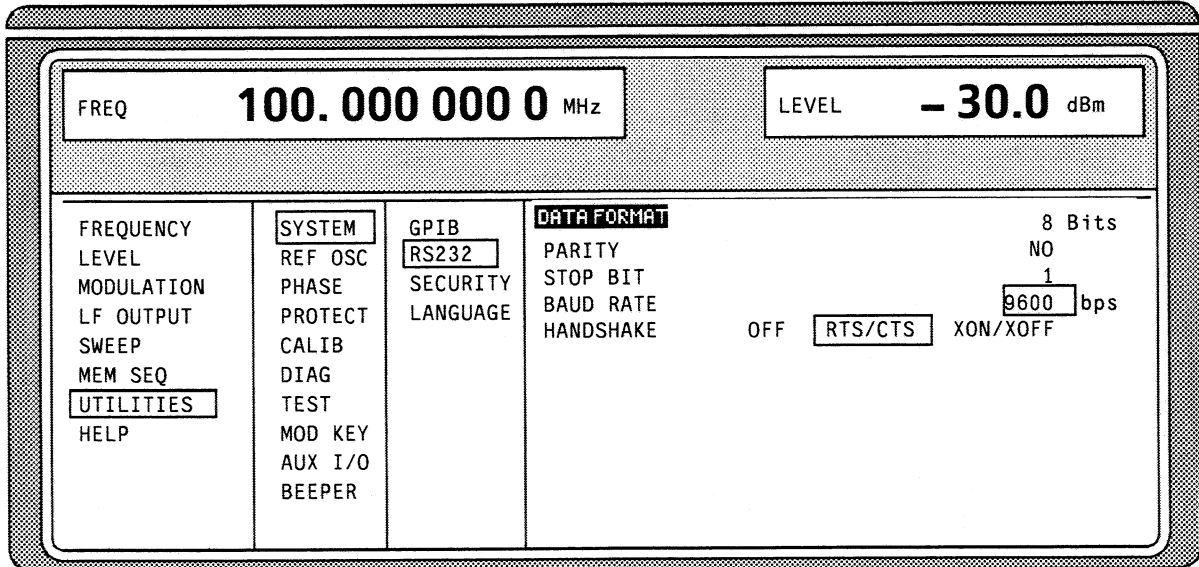

Fig. 2-46 Menu UTILITIES - SYSTEM - RS232

DATA FORMAT	Indication of the number of data bits. This value cannot be changed.
PARITY	Indication of parity. This value cannot be changed.
STOP BIT	Indication of the number of stop bits. This value cannot be changed.
BAUD RATE	Selection of the baud rate. IEC-bus short command : <i>SYST:COMM:SER:BAUD 9600</i>
HANDSHAKE	Selection of the handshake. OFF No handshake IEC-bus short commands : <i>SYST:COMM:SER:PACE NONE</i> : <i>SYST:COMM:SER:CONT:RTS ON</i> RTS/CTS Hardware handshake using the interface lines RTS and CTS. This mode always is to be preferred to XON/XOFF mode, if permitted by the configuration of the host computer. IEC-bus short command : <i>SYST:COMM:SER:CONT:RTS RFR</i> XON/XOFF Software handshake using the ASCII codes 11h <XON> and 13h <XOFF>. This mode is not recommended for binary data and for baud rates above 9600 baud. IEC-bus short command : <i>SYST:COMM:SER:PACE XON</i>

2.10.3 Suppressing Indications and Deleting Memories (SYSTEM-SECURITY)

For security interests, indications can be suppressed and memories deleted in the SYSTEM-SECURITY submenu.

Menu selection: UTILITIES - SYSTEM - SECURITY

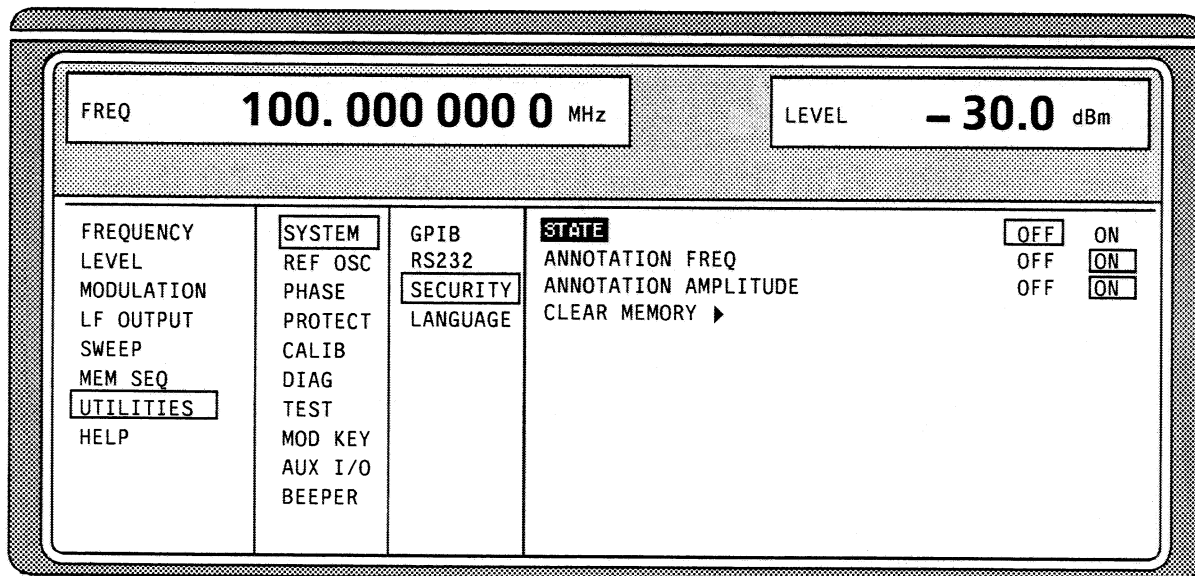

Fig. 2-47 Menu UTILITIES-SYSTEM-SECURITY

- STATE** Selection of the SECURITY state
- ON Locks the suppression of the indications. Can only be set via IEC bus.
 - OFF Deactivates the interlock of the indication suppression. The preset state is set in the transition ON→OFF, and all data stored such as settings, user correction and memory sequence settings stored are deleted. Can only be set via IEC bus.
- IEC-bus short command :SYST:SEC OFF
- ANNOTATION FREQ**
- OFF All frequency indications are suppressed.
 - ON The frequency setting is displayed.
- IEC-bus short command :DISP:ANN:FREQ ON
- ANNOTATION AMPLITUDE**
- OFF All level indications are suppressed.
 - ON The level setting is displayed.
- IEC-bus short command :DISP:ANN:AMPL ON
- CLEAR MEMORY ▶** Deletion of all data stored such as settings, user correction and memory sequence settings stored.
- For this action, two commands are necessary at the IEC bus:
- IEC-bus short command :SYST:SEC ON; SEC OFF

2.10.4 Indication of the IEC-Bus Language (LANGUAGE)

Submenu UTILITIES-SYSTEM LANGUAGE indicates the IEC-bus language and the current SCPI version.

2.10.5 Reference Frequency Internal/External (REF OSC)

In the internal-reference operating mode, the internal reference signal at a frequency of 10 MHz is available at the REF socket (rear of the instrument).

Signal level: V_{eff} (EMF, sine) = 1 V.

The frequency of the internal reference oscillator can be detuned via the TUNE input (rear of the instrument). Input voltage range ± 10 V, pulling range $\pm 1 \times 10^{-6}$.

The external detuning is possible in both states of the ADJUSTMENT STATE (ON or OFF) unless option SM-B1, reference oscillator OCXO, is fitted. If option SM-B1, reference oscillator OCXO, is fitted, the detuning via the TUNE input is only possible if the ADJUSTMENT STATE selection has been switched to ON in the UTILITIES-REF OSC menu.

In the external-reference operating mode, an external signal at a frequency of 5 MHz or 10 MHz is to be fed into socket REF. Synchronization to 5 or 10 MHz is effected automatically.

The message "EXT REF" is displayed in the status line in the header field of the display in the external-reference operating mode.

The REF OSC menu offers access to the settings of the reference frequency.

Menu selection: UTILITIES-REF OSC

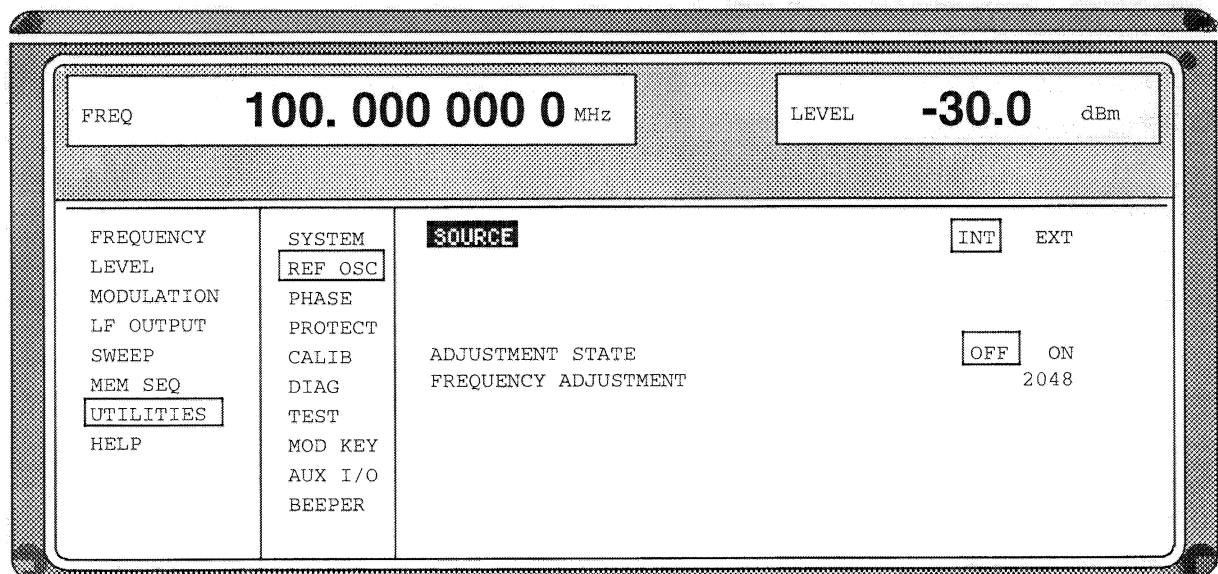

Fig. 2-48 Menu UTILITIES-REF-OSC (preset setting)

SOURCE

Selection of the operating mode.

INT Internal-reference operating mode

EXT External-reference operating mode

IEC-bus short command :ROSC:SOUR INT

ADJUSTMENT STATE

OFF Tuning value of the internal reference frequency as calibrated (cf. menu UTILITIES-CALIB)

ON Tuning value according to setting value FREQUENCY ADJUSTMENT. Option SM-B1, reference oscillator OCXO, is switched off. Only the standard reference oscillator is in operation.

IEC-bus short command :ROSC:ADJ:STAT ON

FREQUENCY ADJUSTMENT

Input value in the range 0 to 4095 to set the internal reference frequency. Pulling range $\pm 4 \times 10^{-6}$.

IEC-bus short command :ROSC:ADJ:VAL 2048

2.10.6 Phase of the Output Signal (PHASE)

Menu UTILITIES-PHASE offers access to the phase setting of the RF output signal with respect to a reference signal of the same frequency.

Menu selection: UTILITIES-PHASE

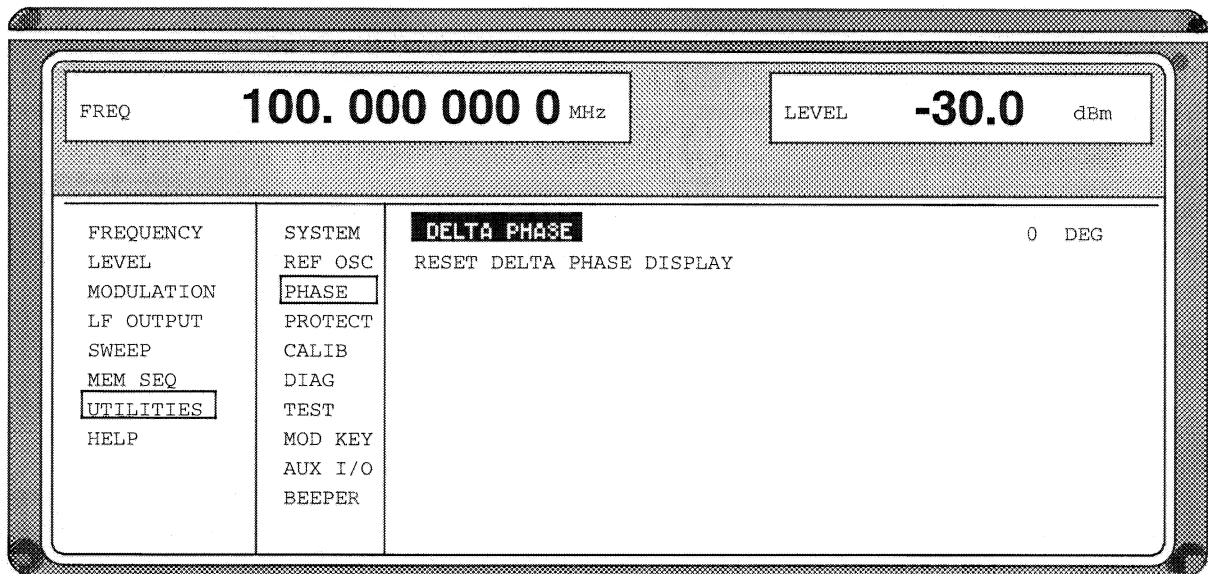

Fig. 2-49 Menu UTILITIES-PHASE (preset setting)

DELTA PHASE

Setting value of the phase

IEC-bus short command *:PHAS 0*

RESET DELTA PHASE DISPLAY

Sets the display of the DELTA PHASE to 0 without the phase of the output signal being influenced.

IEC-bus short command *:PHAS:REF*

2.10.7 Password Input With Functions Protected (PROTECT)

The execution of calibrating and service functions is protected by a password. To unlock the lock-out, the correct password, a 6-digit number, has to be entered and then the [ENTER] key has to be pushed. After the instrument has been switched on, the lock-out is automatically activated.

Password 1 unlocks the lock-out for calibrations LEV PRESET, VCO SYN, FM and PULSE GEN.

Password 2 unlocks the lock-out for calibration REF OSC.

Password 3 permits the input of the serial number and the value of the counter for POWER ON, operating hours and attenuator circuits.

Menu UTILITIES-PROTECT offers access to the unlocking of protected functions.

Menu selection: UTILITIES - PROTECT

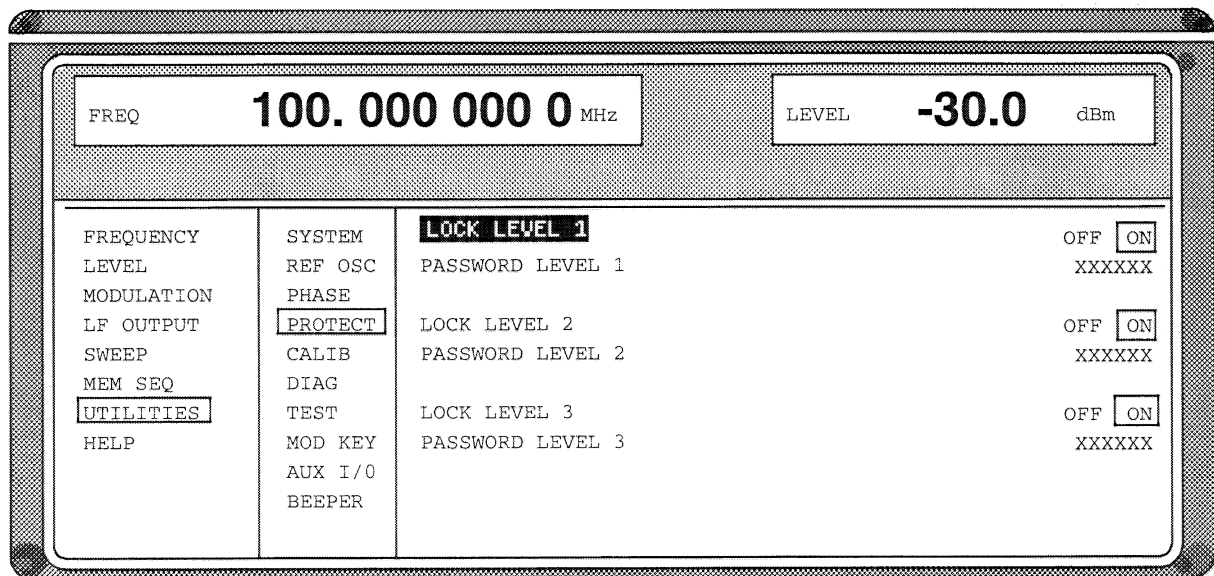

Fig. 2-50 Menu UTILITIES-PROTECT (preset setting)

LOCK LEVEL x

Activating/deactivating the lock-out.

ON The lock-out is activated.

OFF The cursor automatically wraps to the input of the password. After the password has been entered, the lock-out is deactivated.

IEC-bus short command `:SYST:PROT1 ON`

PASSWORD LEVEL x

Input of the password; termination with [ENTER] key.

IEC-bus short command `:SYST:PROT1 OFF, 123456`

2.10.8 Calibration (CALIB)

The following menus offer access to calibrating routines and correction values:

```

UTILITIES - CALIB -VCO SYN
    LEV PRESET
    REF OSC      (cf. service manual)
    LEVEL       (cf. service manual)
    FM
    PULSE GEN
  
```

Internal calibration routines LEV PRESET, VCO SYN, FM and PULSE GEN are protected by a password. They can only be executed if the lock-out in the UTILITIES - PROTECT menu has been unlocked. The password is PASSWORD LEVEL 1 = "123456".

Caution: Execute calibration routines only when the instrument has warmed up.

Calibration routines LEVEL and REF OSC are described in the service manual (stock no. 1039.3359.24).

Calibration VCO SYN

In order to accelerate settling, the oscillator of the synthesizer is preset via a D/A converter. The presetting values are stored in a table and can be renewed using internal calibration routine VCO SYN. The calibration routine needs only be executed after a data loss in the RAM or after an exchange of modules.

Function: In a 10-MHz division scale, the VCOs are synchronized with the rated frequency and the presetting voltage readjusted until the difference to the tuning voltage becomes minimal. The value hence achieved is entered into the table. The routine takes approx. 20 seconds.

Menu selection: UTILITIES-CALIB-VCO SYN

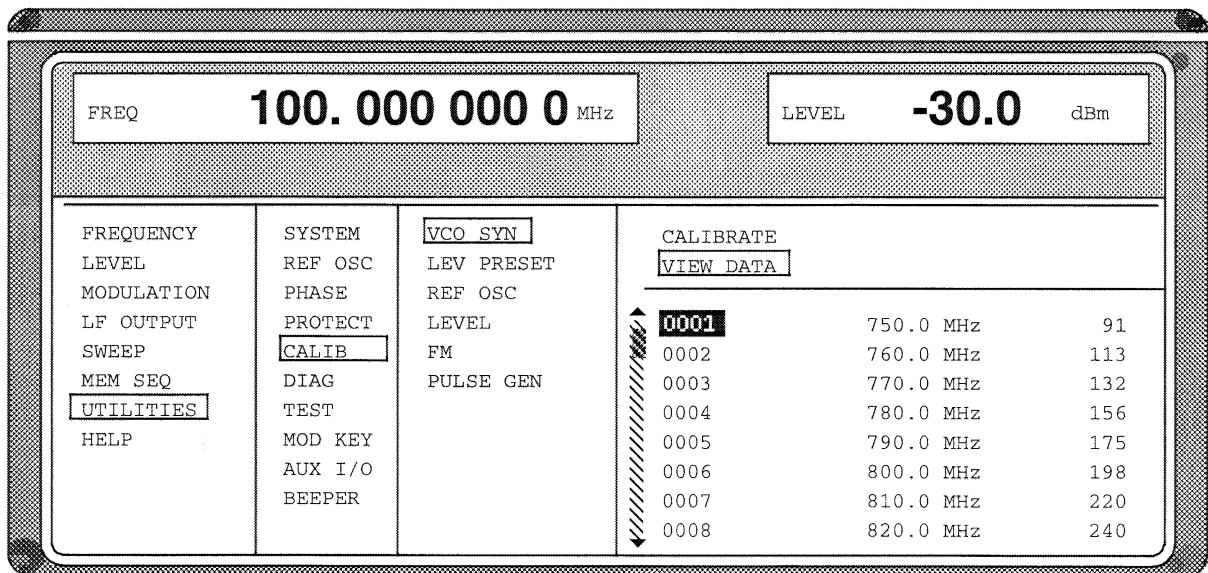

Fig. 2-51 Menu UTILITIES-CALIB-VCO SYN

CALIBRATE Triggers the calibration for the synthesizer PLL.
IEC-bus short command :CAL:VSYN?

VIEW DATA

Indication of the list of presetting values.

The cursor wraps to index 1 of the list. The list can be executed using the rotary knob. This line is the first to be indicated in the segment by means of a value entry of the index using the digit block.

IEC-bus short command :CAL:VSYN:DATA?

Calibration LEV PRESET

In order to hold the amplitude modulator in the optimal working point with all frequency and level settings, a second control element is mounted by means of which the level before the modulator is set in such a way that the modulator always works in the best part of its characteristic. The setting values for the second control element are stored in a table and can be renewed using internal calibration routine LEV PRESET. The calibration routine needs only be executed in the case of a data loss in the RAM or after an exchange of modules.

Function: By alternately adjusting the two level control elements, the calibration routine determines the value for the presetting in which the amplitude modulator is operated at the attenuation demanded. The calibration is executed according to a given frequency table at levels of 13dBm to -2dBm in steps of 3 dB. The routine takes approx. 4 min.

Menu selection: UTILITIES - CALIB - LEV PRESET

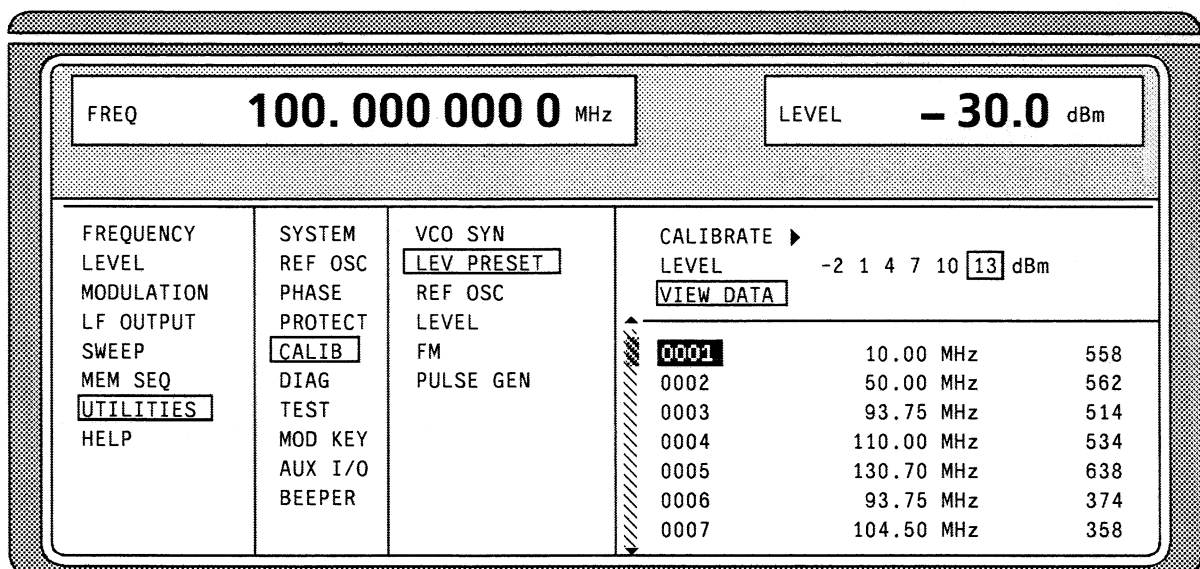

Fig. 2-52 Menu UTILITIES-CALIB-LEV PRESET

CALIBRATE ▶

Triggers the calibration for level preset.

IEC-bus short command :CAL:LPR?

LEVEL

Selection of the level for which the correction values are indicated.

VIEW DATA

The cursor wraps to index 1 of the list. The list can be executed using the rotary knob. This line is the first to be indicated in the segment by means of a value entry of the index using the digit block.

IEC-bus short command :CAL:LPR:DATA?

Calibration FM

The frequency modulation is generated via two paths by modulation of the division factor of the PLL as well as by the direct modulation of the oscillator. The modulation sensitivity of the oscillator is frequency-dependent. The calibration routine determines correction factors to balance the fluctuating modulation sensitivity in steps of 10 MHz. The routine is to be executed in the case of larger variations of the temperature, data loss in the RAM or an exchange of modules. It takes approx. 1 min.

Menu selection: UTILITIES - CALIB - FM

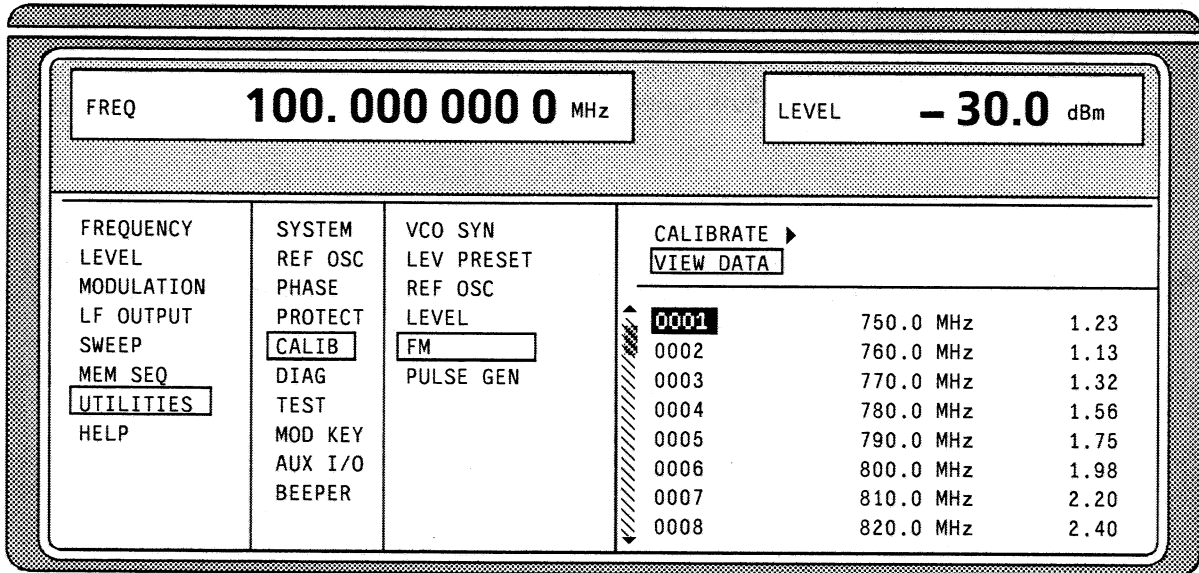

Fig. 2-53 Menu UTILITIES-CALIB-FM

CALIBRATE ▶

Triggers the calibration for the FM.

IEC-bus short command :CAL:FM?

VIEW DATA

Indication of the list of correction values.

The cursor wraps to index 1 of the list. The list can be executed using the rotary knob. This line is the first to be indicated in the segment by means of a value entry of the index using the digit block.

IEC-bus short command :CAL:FM:DATA?

Calibration PULSE GEN

A programmable oscillator determines the accuracy of the pulse width and the pulse delay of the pulse generator. To compensate for the temperature dependence of the oscillator (approx. 0.2%/degree) an internal calibration is offered. The adjustment accuracy is approx. $\pm 0.5\%$. The calibration routine is to be executed even after a data loss in the RAM or after an exchange of modules.

Function: The frequency of the oscillator is measured using a counter which is synchronized with the crystal reference. The oscillator is readjusted until the deviation is minimized. The calibration value thus achieved is stored.

Menu selection: UTILITIES - CALIB - PULSE GEN

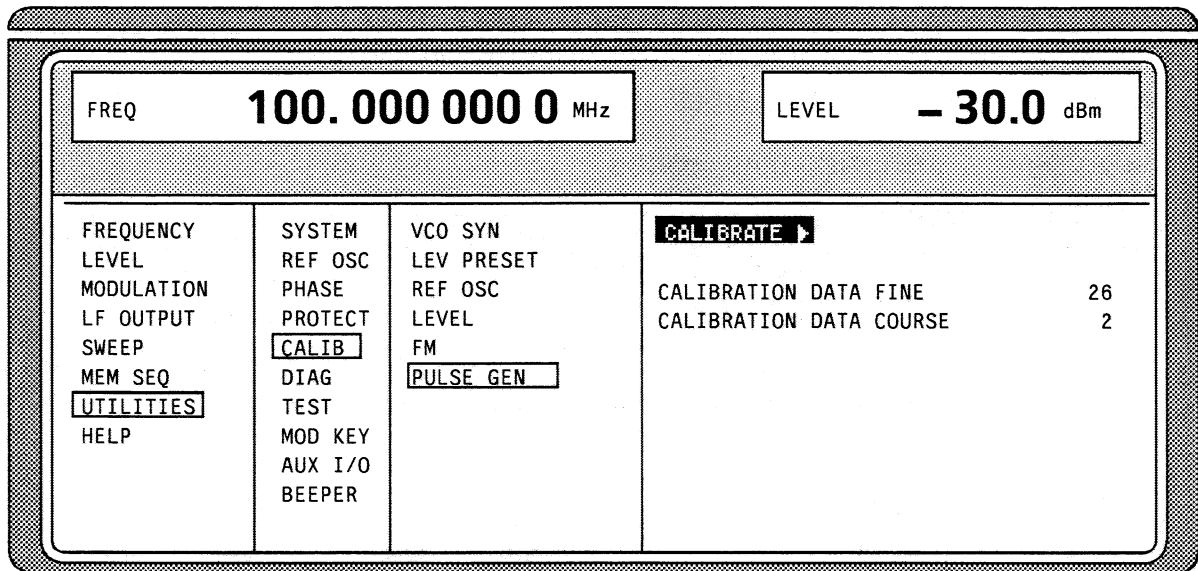

Fig. 2-54 Menu UTILITIES-CALIB-PULSE GEN

- CALIBRATE** ▶ Triggers the calibration for the pulse generator.
IEC-bus short command :CAL:PULS?
- CALIBRATION DATA FINE** Indication of the fine adjustment in decimal form.
IEC-bus short command :CAL:PULS:DATA?
- CALIBRATION DATA COURSE** Indication of the coarse adjustment in decimal form.
IEC-bus short command :CAL:PULS:DATA?

2.10.9 Indication of Module Variants (DIAG-CONFIG)

For service purposes, the modules installed can be indicated with their variants and states of modification. Submenu DIAG-CONFIG offers access to the module indication.

IEC-bus short command :DIAG:INFO:MOD?

Menu selection: UTILITIES - DIAG - CONFIG

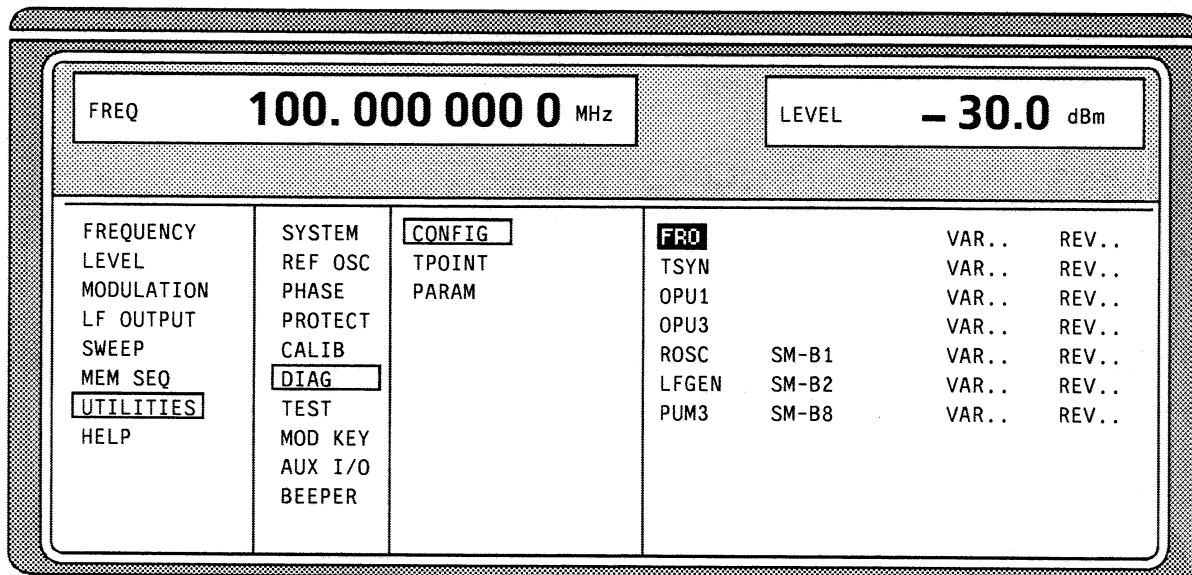

Fig. 2-55 Menu UTILITIES-DIAG-CONFIG

2.10.10 Voltage Indication of Test Points (DIAG-TPOINT)

Submenu DIAG-TPOINT offers access to internal test points. If a test point is switched on, the voltage indication is displayed in a window in the header field. For greater detail, see service manual (stock no. 1039.3359.24).

Menu selection: UTILITIES - DIAG - TPOINT

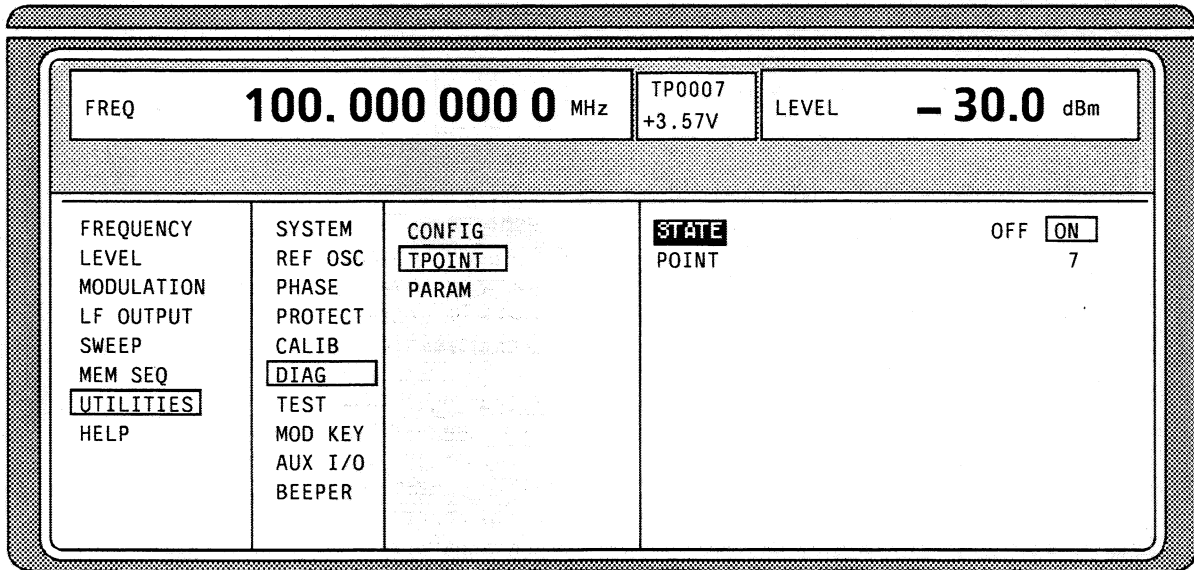

Fig. 2-56 Menu UTILITIES-DIAG-TPOINT

STATE

Switching on/off the voltage indication.

POINT

Input value of the test point.

IEC-bus short command :DIAG:POINxx?

2.10.11 Indication of Service Data (DIAG-PARAM)

Submenu DIAG-PARAMETER offers access to different parameters such as serial number, software version, operating-hours counter and attenuator circuits.

Menu selection: UTILITIES - DIAG - PARAM

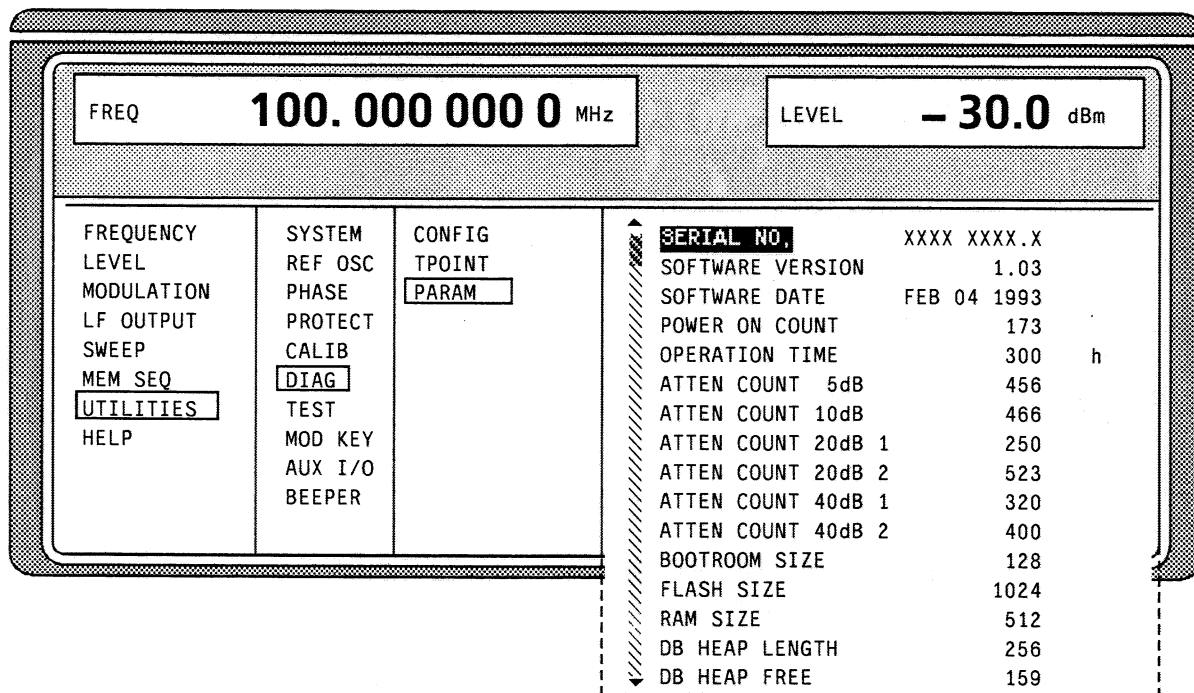

Fig. 2-57 Menu UTILITIES-DIAG-PARAM

For IEC-bus commands, cf. Section 3.6.5, DIAGnostic System.

2.10.12 Test (TEST)

(cf. Section 4.2, Functional Test)

2.10.13 Assign Modulations to the [MOD ON/OFF] Key (MOD-KEY)

The modulations can be switched on/off in the individual modulation menus and parallelly by means of the [MOD ON/OFF] key.

For which modulations the [MOD ON/OFF] key is effective can be defined in the UTILITIES-MOD KEY menu. The key can either be effective for all modulations or for a selected one.

Function of the [MOD ON/OFF] key if effective for a type of modulation:

- ▶ Every pressing a key alters the state (ON or OFF) of the selected modulation.

Function of the [MOD ON/OFF] key if effective for all types of modulation (ALL):

- ▶ If at least one modulation is switched on, pressing the [MOD ON/OFF] key switches the modulation/s off. Which modulations were switched on is stored.
- ▶ If no modulation is switched on, pressing the [MOD ON/OFF] key switches on the modulations which were last switched off using the [MOD ON/OFF] key.

On switching on using the [MOD ON/OFF] key, the modulation sources are used as defined in the modulation menus.

Access to the selection of the modulation to be switched using the [MOD ON/OFF] key is possible in the UTILITIES-MOD KEY menu.

Menu selection: UTILITIES - MOD KEY

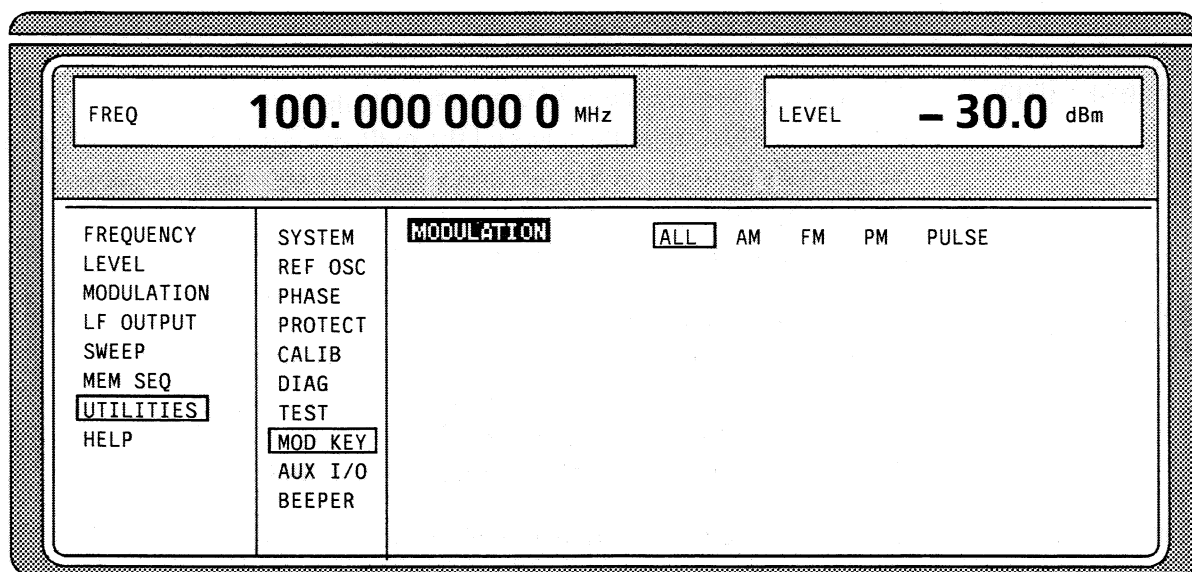

Fig. 2-58 Menu UTILITIES-MOD KEY (preset setting)

MODULATION Selection for which modulation the [MOD ON/OFF] key is to be effective.

Note: Preset switches off all modulations, sets the selection to ALL and stores AM 30%, AM SOURCE INT: LF GEN1 as default setting.

2.10.14 Set Auxiliary Inputs/Outputs (AUX I/O)

Menu UTILITIES - AUX I/O offers access to settings for the TRIGGER input, BLANK output and MARKER output. Sections Sweep and Memory Sequence provide further information.

Menu selection: UTILITIES - AUX I/O

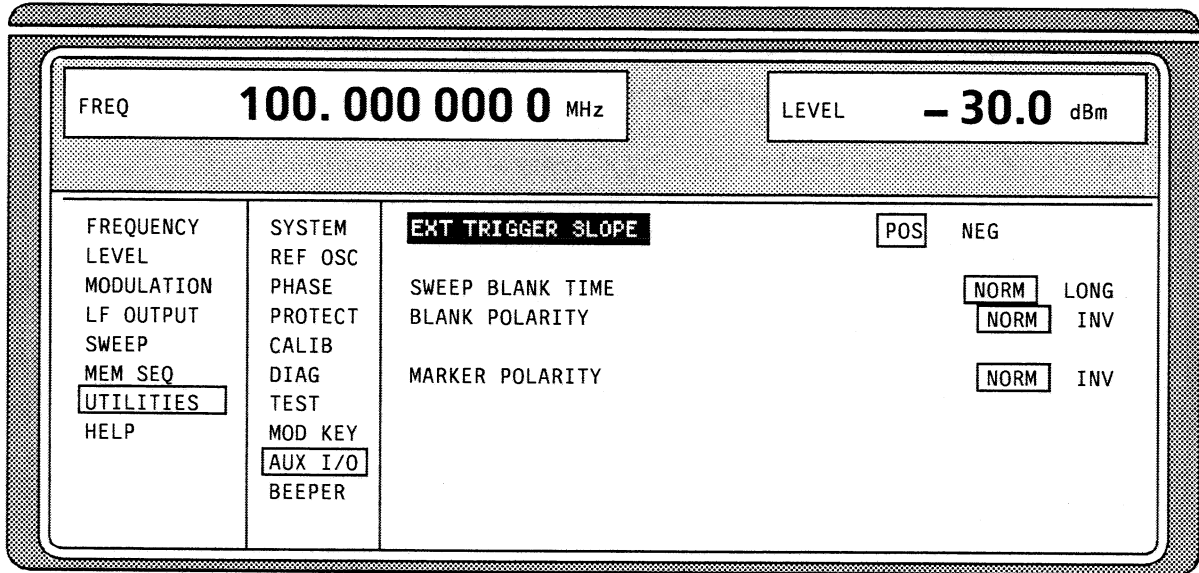

Fig. 2-59 Menu UTILITIES - AUX I/O

EXT TRIGGER SLOPE

Selection of the active edge of the external trigger signal.

POS The instrument triggers on the positive edge of the external signal.

NEG The instrument triggers on the negative edge of the external signal.

IEC-bus short command :TRIG:SLOP POS

SWEEP BLANK TIME

Selection of the blank duration.

NORM BLANK duration is set to the shortest duration possible.

LONG The BLANK duration is set for the PEN LIFT control of an XY recorder (approx. 500ms).

IEC-bus short command :SOUR2:SWE:BTIM NORM

BLANK POLARITY

Selection of the polarity for the blank signal.

NORM With active BLANK, the output signal is HIGH.

INV Polarity is inverted.

IEC-bus short command :OUTP:BLAN NORM

MARKER POLARITY

Selection of the polarity for the marker signal.

NORM The output signal is HIGH when the sweep cycle reaches the mark.

INV Polarity is inverted.

IEC-bus short command :MARK:POL NORM

2.10.15 Switching On/Off Beeper (BEEPER)

Menu UTILITIES-BEEPER offers access to the switching on/off of the beeper.

Note: Preset does not alter the current state (ON or OFF).

Menu selection: UTILITIES -BEEPER

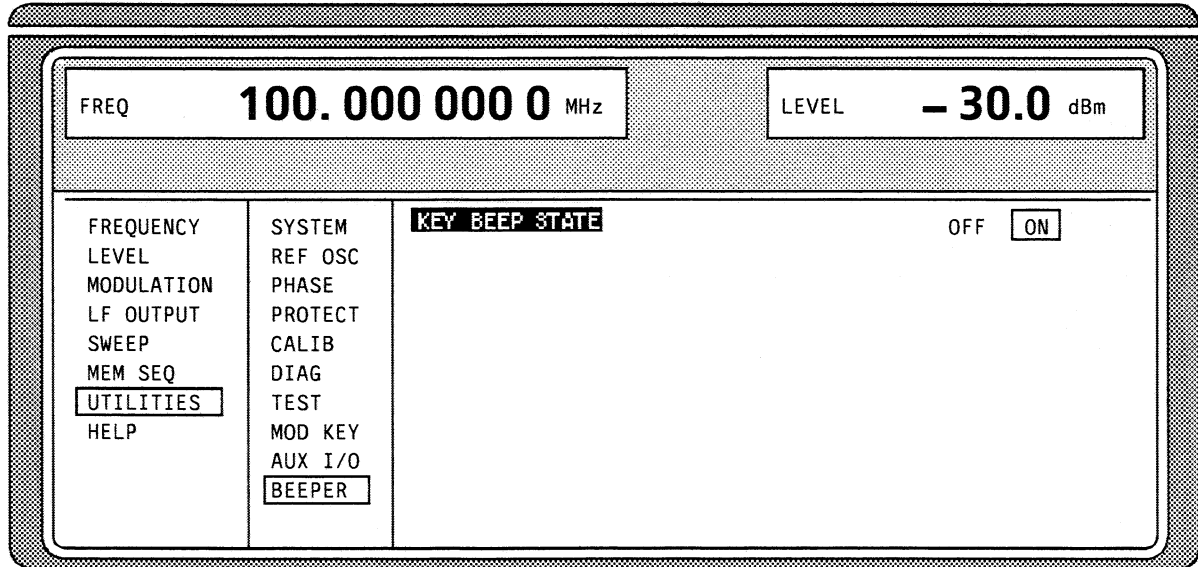

Fig. 2-60 Menu UTILITIES - BEEPER

KEY BEEP STATE Switching on/off the beeper
IEC-BUS command :SYST:BEEP:STAT ON

2.11 The Help System

The SMT has two help systems. On the one hand the context-sensitive help which is called by means of the HELP key and which gives information on the current menu. On the other hand, auxiliary texts can be selected according to headwords in alphabetical order by accessing menu HELP.

HELP Key

The yellow HELP key can be pressed at any point in time. The current setting menu is faded out and context-sensitive text faded in. The help panel can be exited by means of the RETURN key.

Menu HELP

After calling the help menu, access to all auxiliary texts is possible via an index. Operation is analog to menu operation.

- ▶ Set the menu cursor to the index desired using the shaft encoder.
- ▶ Press the [SELECT] key.
The information for the index marked is displayed.
- ▶ Press the [RETURN] key to exit the menu.

2.12 Status

By means of a STATUS page, the SMT permits an overview over all settings of the instrument. The settings are displayed in an abbreviated form. The STATUS page is called by pressing the [STATUS] key. Return to the preceding menu is effected using the [RETURN] key.

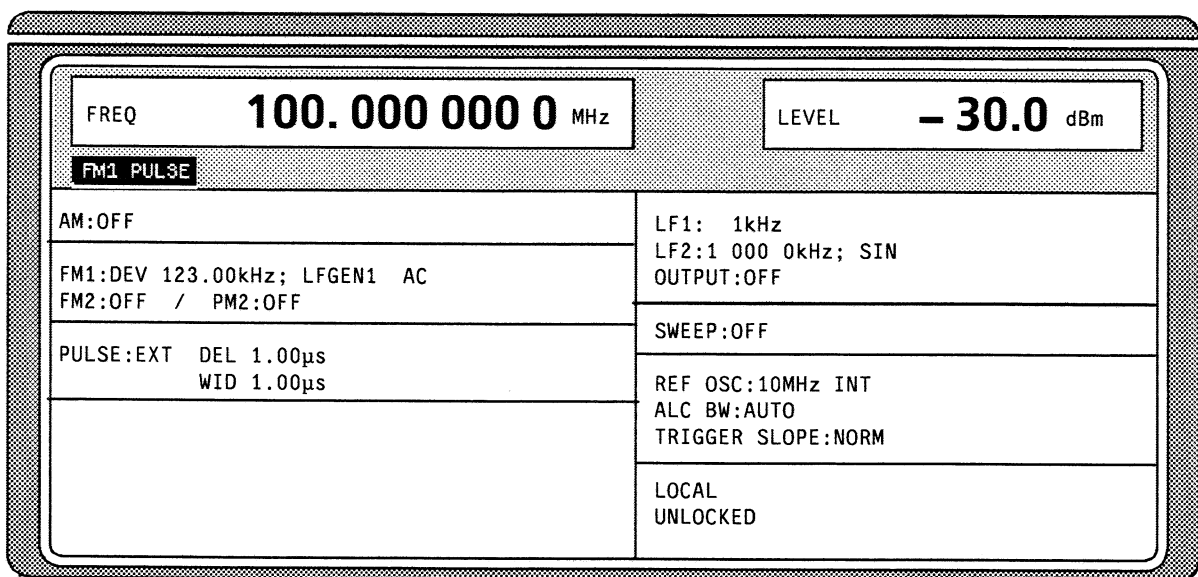

Fig. 2-61 STATUS page

2.13 Error Messages

The SMT displays error and caution messages in a different manner, depending on how long, for a short period of time or permanently, the cause exists.

Short-term message The short-term message is displayed in the status line. Part of it overwrites the status indications and disappears after approx. 2 seconds or in the case of a new entry.

The instrument shows, e.g., short-term messages if the attempt is made to enter an overrange or if incompatible operating modes deactivate one another.

Long-term message The long-term message is displayed in the status line by means of the message "WARNING" or "ERROR". Pressing the [ERROR] key calls the ERROR page in which the messages are entered. Several messages can be entered at the same time. The long-term message remains existing until there is no cause any more. The ERROR page is exited using the [RETURN] key.

The instrument displays, e.g., the long-term message "ERROR" if there is a hardware error or "WARNING" if overrange settings have been made.

Notes: – An error message "ERROR" does not necessarily point to a defect instrument. There are various operating states which can cause an ERROR message. E. g. if the instrument is set to external reference but no external reference is connected.

- Error 313 indicates the loss of calibration data and is also applicable in case of a cold start (key [PRESET] is pressed during switch-on). The calibration values can be restored with internal calibration routines. These routines are accessible via menu UTILITIES-CALIB (see section on calibration).

The ERROR page offers access to long-term messages if the [ERROR] key is pressed.

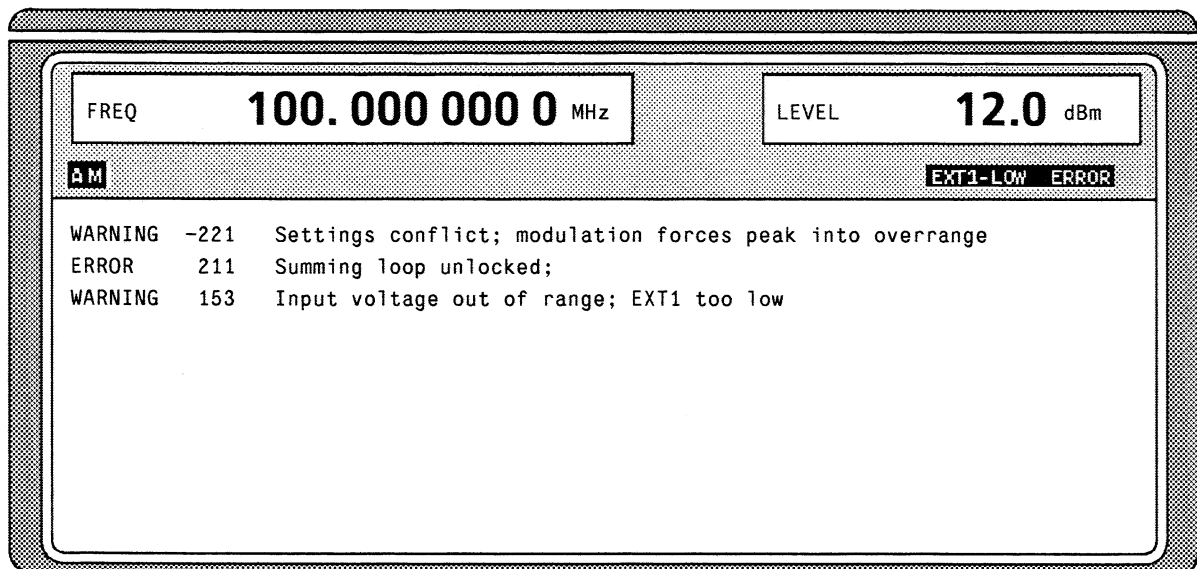

Fig. 2-62 ERROR page

A list of the possible error messages is to be found in annex B.

